

The K point
of view

Concealed
HINGES

Krona
Koblenz



KRONA KOBLENZ

For over 30 years we have been manufacturing adjustable concealed hinges and cutting-edge solutions for doors and furniture.

We plan our success and develop each activity in Coriano, Italy, in Krona Koblenz headquarter. Our Customers' needs are the background of our research.

Our Partners

We support our customers and partners because the best achievements come from their feedback: experience sharing gives us the inspiration to create new solutions and the motivation to push ourselves into new challenges.

Research and Development

Idea planning is a particular and very important phase; for this reason, the development is supported by rapid prototyping machines and certified test benches to obtain the best result.

Patents

We strongly believe in our ideas, this is why many of our products are protected by international patents.

Certifications

The certifications obtained by most of our hinges, according to the most important standards that regulate construction products, demonstrate the quality and reliability of our products.

Corporate Certifications



Krona Koblenz SpA adopts ISO 9001 certified quality management system, ensuring controlled processes, operational efficiency and continuous improvement, in order to offer products and services to the customers that meet the highest international standards.



ONLINE CONSULTING

Are you working on a project and are you looking for a solution or an alternative to a problem?

Do you have doubts about the assembly or adjustment of one of our systems?

We have the right service for you!



Book a consultation with one of our experts by fixing the time that best suits you: we will be at your disposal to find a solution at any stage of your project. We will support you in the preliminary phase, in the executive design phase, but also during the installation or after-sales assistance without leaving your customers alone.

BOOK A CONSULTATION



SERVICES FOR YOU

We have designed and created tools and services to simplify the work of those who have decided to apply our products.

Catalogue

The catalogue you are browsing is not just an update of the previous one, but it is a real guide that will help you choosing the hinge that best suits your needs in just a few steps: on its pages we will help you to avoid mistakes and find your perfect hinge among the numerous ones we have in the range which we have divided into 3 series: Performance, Evolution and Classic.

Website

Even our website has become simple: starting from your needs, in a few clicks we will guide you until you get a selection of hinges suitable for your requirements. Try it now!

Design utilities

Simplified design with the new download area where you can download BIM, 3D, 2D CAD and media files, assembly instructions, certifications and much more.

Video tutorial

We care about whoever installs our products: for this reason you can make proper adjustments thanks to our video tutorials. It only takes a minute to get all the information you need!

Online consulting

Do you still have questions or did anything go wrong?

There is a technical sales consultant ready to help you, book a free consultation at our website. We are sure that we will find a suitable solution for you.

Training

News, updates and practical tests directly with the product are possible with our K-Mobile: a car equipped with our product range is on the move throughout the country with our sales technicians who visit our partners.

Interactive PDF catalog

Do you want to get the catalogue always updated? We offer an interactive PDF for easy consultation even from smartphones and laptop. Scan the QR Code and add the link to your favorites to always access the latest version of our catalogue.



Pag.		
7	<h2>Vademecum</h2>	The factors to consider when choosing a hinge..... 9 Door weight and dimensions10 Hinge spacing.....11 Load capacity table 12 How many hinges to install.....14 Accessories.....16 Door placing 17 Certifications18
22	<h2>Performance Series</h2> (steel hinges)	Atomika K8000 24 Atomika Slim K8060 26 Atomika Karakter K8080 28 Atomika Karakter K8120 30 KuBi7 Kinox K7316 32
34	<h2>Evolution Series</h2> (hybrid hinges: in steel, zamak, aluminum and plastic)	Kombi Hybrid K1019 36 Kombi Hybrid K1019 26 38 Kombi Hybrid K1019 30 40 Kombi Hybrid K1019 34 42 Kombi Hybrid K1060 44 Kombi Hybrid K1060 26 46 Kombi Hybrid K1060 30 48 Kombi Hybrid K1060 34 50 Kubica K2460 52 Kubica K6360 38 54 Kubica K6360 45 56 Kubica K2760 58 Kubica K2780 60 Kubica K6380 38 62 Kubica K6380 45 64
66	<h2>Classic Series</h2> (zamak hinges)	Kubikina New K6100 68 Kubica KubiCenter K6400 70 KuBi7 K7000 72 Kubica K6200 74 Kubica KubiKuadra K3000 76 Kubica K6700 78 Kubica K6300 80 Kubica 27 K2700 82 KuBi7 Kubica Twist K2000 84 Kubica K5080 86 KuBi7 K7080 88 Kross8 100 K2810 90 KuBi7 K7120 92 Kross8 160 K2816 94 KuBi7 K7200 96



100	Cover caps finishes and spare parts	Finish samples 100 Cover caps spare parts 101 Spacers magnetic cover 104
105	Accessories	Universal jig 105 Templates 105 Receivers 106 Adjustable plate 106 Standard fixing plate 107 Cover tool 107
108	Warnings and recommendations	Warnings and recommendations 108 How to calculate the door weight 108 Frame and door fixing 108 Installation and adjustment 109 Painting / Product alterations 109 Hinge maintenance 110 Lubrication 110 Cleaning 110 Ordinary maintenance 110 Installer's reminder 111



Vademecum



Warnings

Accessories

Finishes

Classic Series

Evolution Series

Performance Series

Legenda

Vademecum

Index

THE FACTORS TO CONSIDER WHEN CHOOSING A HINGE

To identify the correct hinge to install on a door and ensure its efficient functioning, there are various factors to be taken into consideration. The following recommendations are meant to highlight some crucial points to focus attention on and to explain some of the involved principles.

Door weight and dimensions

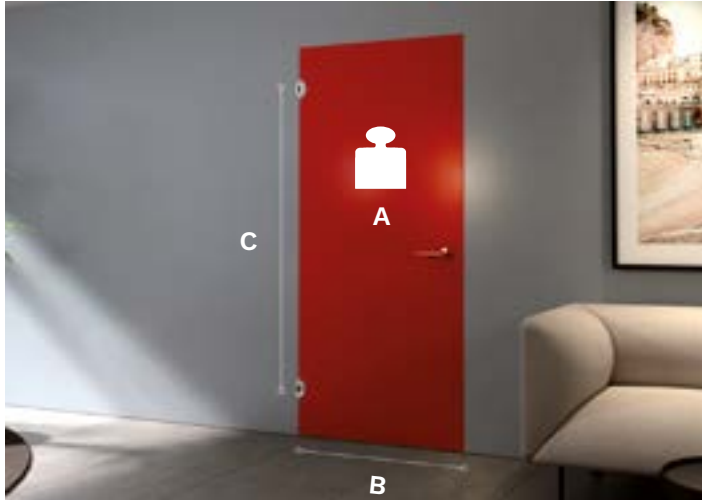

Hinge spacing



Accessories



Door placing



Certifications



DOOR WEIGHT AND DIMENSIONS

Door weight and dimensions determine the hinge selection.

The stress on the hinges is due to:

- Door weight [**A**]
- Door width [**B**]
- Hinge spacing (explanation on page 11) [**C**]

⚠ As the door weight or width increases, or as the hinge spacing decreases, the hinge is subjected to a greater stress.



HINGE SPACING

We define hinge spacing as the distance between the center of the top hinge and the center of the bottom hinge on the door leaf, whether or not there are other hinges between them.

⚠ The hinge spacing influences the hinge load capacity. The smaller hinge spacing is, the lower hinge capacity is.



Load capacity table

It's a reference table which determines the maximum hinge capacity based on the door width and hinge spacing.

⚠ In order to maintain the load capacity, it may be required to increase the hinge spacing when the door leaf width is greater than the tested door dimension.

How to read the load capacity table

The Y axis indicates the distance between the hinges and the X axis indicates the door leaf width. By crossing the X and Y axes we get the hinge capacity.

The dimensions highlighted in green in the table below indicate combinations for which the hinge maintains its best performance. In this case capacity 60 kg with 2 hinges.

K8060 - 60kg		700	800	900	950	1000	1050	1100	1150	1200	1250	1300
2000	60	60	60	60	60	60	60	60	60	60	58	56
1950	60	60	60	60	60	60	60	60	60	58	56	54
1900	60	60	60	60	60	60	60	60	60	57	55	53
1850	60	60	60	60	60	60	60	60	58	56	54	52
1800	60	60	60	60	60	60	59	56	54	52	50	48
1750	60	60	60	60	60	60	57	55	53	51	49	47
1700	60	60	60	60	60	58	56	53	52	49	47	45
1650	60	60	60	60	60	57	54	52	50	48	46	44
1600	60	60	60	60	58	55	52	50	48	46	44	42
1550	60	60	60	59	56	53	52	49	47	45	43	41
1500	60	60	60	57	54	52	49	47	45	43	41	39
1450	60	60	58	55	52	50	48	45	44	42	40	38

All Krona Koblenz hinges are tested on IFT certified test benches and according to EAD 020001-01-0405 standard. The data highlighted in orange (center distance, panel width and load capacity) show the characteristics used during the test.

Example of use to maximize the performance

Assuming the installation of 2 K8060 hinges in a door 2100 mm high, 900 mm wide and with a hinge spacing of 1500 mm, a load capacity of 60 kg would be reached.

K8060 - 60kg		700	800	900	950	1000	1050	1100	1150	1200	1250	1300
2000	60	60	60	60	60	60	60	60	60	60	58	56
1950	60	60	60	60	60	60	60	60	60	58	56	54
1900	60	60	60	60	60	60	60	60	60	57	55	53
1850	60	60	60	60	60	60	60	60	58	56	54	52
1800	60	60	60	60	60	60	59	56	54	52	50	48
1750	60	60	60	60	60	60	57	55	53	51	49	47
1700	60	60	60	60	60	58	56	53	52	49	47	45
1650	60	60	60	60	60	57	54	52	50	48	46	44
1600	60	60	60	60	58	55	52	50	48	46	44	42
1550	60	60	60	59	56	53	52	49	47	45	43	41
1500	60	60	60	57	54	52	49	47	45	43	41	39
1450	60	60	58	55	52	50	48	45	44	42	40	38





By increasing the door leaf width to 1000 mm (leaving the hinge spacing unchanged), the hinge load capacity drops to **54** kg.

1500 mm

Hinge spacing (mm)

1000 mm

Door leaf width (mm)

Hinge spacing (mm)	500	700	800	900	950	1000	1050	1100	1150	1200	1250	1300	1350	1400
2000	60	60	60	60	60	60	60	60	60	60	60	60	58	54
1950	60	60	60	60	60	60	60	60	60	60	59	56	54	54
1900	60	60	60	60	60	60	60	60	60	60	57	55	54	54
1850	60	60	60	60	60	60	60	60	60	58	56	53	52	52
1800	60	60	60	60	60	60	60	59	56	54	52	50	50	50
1750	60	60	60	60	60	60	57	55	53	51	49	47	47	47
1700	60	60	60	60	60	58	56	53	51	49	47	45	45	45
1650	60	60	60	60	60	57	54	52	50	48	46	44	44	44
1600	60	60	60	60	58	56	52	50	48	46	44	42	42	42
1550	60	60	60	59	56	53	50	49	47	45	43	41	41	41
1500	60	60	60	57	54	52	49	47	45	43	41	39	39	39
1450	60	60	58	55	52	50	48	46	44	42	40	38	38	38

To obtain again a **60** kg capacity with a door leaf width of 1000 mm, it is necessary to increase the hinge spacing to at least 1650 mm. If the hinges are already placed at the far end of the door leaf, the load capacity will remain at 54 kg.

1650 mm

Hinge spacing (mm)

1000 mm

Door leaf width (mm)

Hinge spacing (mm)	500	700	800	900	950	1000	1050	1100	1150	1200	1250	1300	1350	1400
2000	60	60	60	60	60	60	60	60	60	60	60	60	58	54
1950	60	60	60	60	60	60	60	60	60	60	59	56	54	54
1900	60	60	60	60	60	60	60	60	60	60	57	55	54	54
1850	60	60	60	60	60	60	60	60	60	58	56	53	52	52
1800	60	60	60	60	60	60	60	59	56	54	52	50	50	50
1750	60	60	60	60	60	60	57	55	53	51	49	47	47	47
1700	60	60	60	60	60	58	56	53	51	49	47	45	45	45
1650	60	60	60	60	60	57	54	52	50	48	46	44	44	44
1600	60	60	60	60	58	56	52	50	48	46	44	42	42	42
1550	60	60	60	59	56	53	50	49	47	45	43	41	41	41
1500	60	60	60	57	54	52	49	47	45	43	41	39	39	39
1450	60	60	58	55	52	50	48	46	44	42	40	38	38	38

💡 Krona Koblenz always recommends increasing the hinge spacing for a minor door sagging over time and a greater hinge resistance.

How many hinges to install

Practical hints highlighting when to install 2, 3 or 4 hinges.

2 hinges

For doors with a height of 2000-2100 mm and a width of up to 900 mm, the installation of 2 hinges is recommended.



3 hinges

The use of 3 hinges is recommended in the following cases:

- doors higher than 2100 mm;
- doors to be installed in a damp environment;
- doors made of thin or light materials;
- door dividing spaces with very different temperatures.

The third hinge, to be installed in the centre, helps to keep the door leaf aligned.





4 hinges

For doors higher than 2100 mm and with a width greater than 900 mm, or for installations in frequently visited public places (for example in schools, hospitals or airports), the installation of 4 hinges is recommended. The fourth hinge works as a support for the upper one, to be installed 250 mm away from the upper hinge.



The accessories we install on the door affect both the performance and the lifetime of the hinge. Below there are some examples of doors with accessories and their relative positioning.

Doors with top closers

If there is a door closer, 3 hinges are required. The third hinge acts as a support for the lower one, to be installed 250 mm away from the upper hinge.

 The recommended adjustment of the door closer must be just enough to make it work. The excessive force of the door closer could compromise the functioning of the hinges. Furthermore, if the installed door closer has the "opening limiter*" function, it must be deactivated to ensure the longer lifetime of the hinge.

*Opening limiter is a function of the door closer which allows you to limit the opening of the door to a smaller angle than the one the hinge would allow.



Doors with doorstops or dropdown seals

With one of these accessories, 3 hinges are required. The third hinge works as a support for the lower one, to be installed 250 mm away from the lower positioned hinge.

 The doorstop should be mounted as far away as possible from the door rotation axis. We recommend the installation at a distance of approximately 75% of the door width in the direction of the lock.

 The recommended dropdown seal setting must be just enough to make it work. Excessive pressure of the dropdown seal on the floor could compromise the work of the hinges.

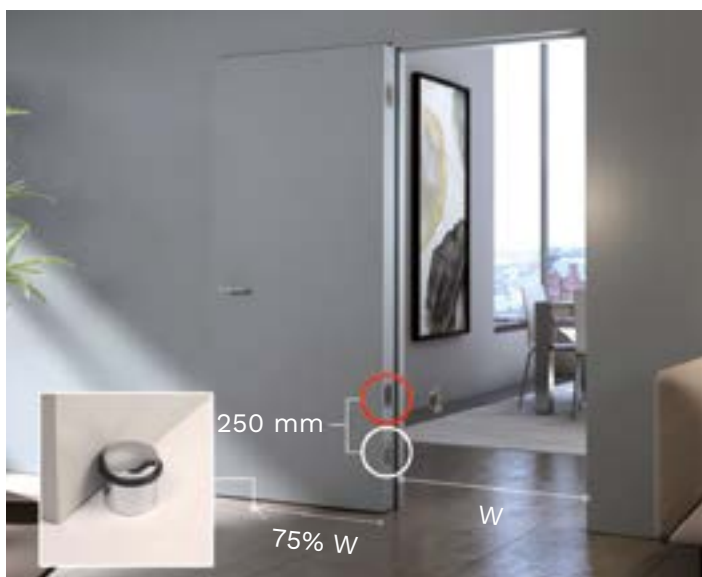

DOOR PLACING

There are 2 door placing types to be taken into consideration: public and private.

In buildings with a high public flow there is a high working intensity due to the frequent opening and closing. Even if the door weight does not require it, use the hinges with higher load capacity characteristics.



Insight:

In a **public** environment, hinges make part of category 3 or 4 of the classification table represented by the European standard EN 1935-2002.

In particular:

- Category 3: Heavy use. Hinges applied to doors in the buildings with a high frequency of use by the public or other users, with little care and a high risk of accidents or incorrect use.
- Category 4: Very heavy use. Hinges applied to doors subject to a frequent violent use.

Hinges in a **private** environment make part of category 1 and 2 of the classification table represented by the European standard EN 1935-2002.

In particular:

- Category 1: Moderate use. Hinges applied to interior doors or windows or other indoor places and in buildings where there is a low frequency of use and a particular care from the side of a user and a low risk of accidents or incorrect use.
- Category 2: Medium use. Hinges applied to interior doors or windows or other indoor places and in buildings where there is a medium frequency of use and a certain amount of care from the side of a user, but where there is a risk of accidents or incorrect use.



CERTIFICATIONS

Krona Koblenz hinges are tested according to strict standards which prove the full product correspondence to the best performance parameters.

The certifications provided by Krona Koblenz are obtained according to the most important standards that regulate construction products.

Based on the performance and production processes, Krona Koblenz products have obtained certifications for: Fire resistance, Functional durability, Corrosion resistance, CE and EPD.

Product tests:

- **Fire resistance:** tests carried out according to the reference standards for doors and closing systems which indicate fire resistance and smoke dispersion control. The acronym EI identifies a construction element which maintains, for a specific time "t", the resistance to flames, hot gases and thermal insulation.

Regulatory standards

EN 1634-1



BS476-22



ANSI/UL 10C



ANSI/UL 10B



CAN /ULC S104



GOST-R53307



- **Functional durability:** indicates the number of cycles, for which full operating efficiency is guaranteed. The test involves moving a door weighing equal to the maximum capacity of a pair of hinges for a given number of cycles. At the end of the cycles, there must be no yielding beyond the limits indicated by the reference standard.

Regulatory standards

EN 1935



EAD
020001-01-0405



EN 1191



- **Corrosion resistance:** it is a parameter that indicates, according to certain requirements, the degree of resistance to corrosion of door accessories.

The parameter assumes particular importance in the environment with high atmospheric corrosion such as industrial or maritime one.

The European reference standard EN1670 requires the hinges to be subjected to a salt spray treatment for up to 240 hours.

Regulatory standards

EN 1670





- **CE:** it is a declaration of performance and constancy of performance according to the reference European standards for the product category.

The CE MARK implicitly declares that the product is provided with specific documents, regulatory tests, inspections the conformity of which has been ascertained by a notified body (IFT - Rosenheim). Regular inspection by authorized certification bodies is necessary to maintain the CE mark and verify the conformity of production machines and processes.

Regulatory standards

EOTA procedure as per
CPR introduced in 2013



Production process tests:

- **EPD – Environmental Product Declaration**

DIN ISO 14025



 The certification achieved by the hinge refers to the performance under the specific conditions. This means that a hinge certified for a capacity of 80 kg with the installation of 2 hinges will only be guaranteed by the certification for a capacity of 80 kg even if a third hinge is installed to try to increase the overall capacity.

REGULATORY BODIES



DURABILITY TEST BENCH

The attention we pay to the reliability of the hinges has led us to install test benches, including one certified by IFT, which we use to test ALL the hinges for multiple durability tests in accordance with the Test protocol specified by the regulations EAD_020001-01- 0405, EN1935 and/or EN1191.

Durability test bench:





Concealed
HINGES



Warnings

Accessories

Finishes

Classic Series

Evolution Series

Performance Series

Legenda

Vademecum

Index

Hinges made of **steel** to achieve high performance.

Steel guarantees **high mechanical resistance** and **elastic deformation** capacity, characteristics that allow a better response to stress compared to the hinges made of traditional materials and with usual processes.











Thanks to the characteristics of steel, the performance series has been also improved in terms of **durability**, i.e. increased number of use cycles, but also a more **stable adjustment over time** and an **excellent fluidity of movement** thanks to its 7 fulcrums.

Atomika hinges are produced with a special **cold production process** (deep drawing) with low environmental impact compared to other classic hinges.

Characteristics of steel hinges

1. Easy to adjust (Atomika range has assisted, self-bearing and independent adjustments)
2. After the first adjustment, the door alignment is more stable over time compared to zamak classic hinges.
3. Lower environmental impact thanks to their cold production process (deep drawing).
4. High Functional durability (over 200,000 cycles)
5. Greater resistance to mechanical stress compared to classic zamak hinges.
6. High Corrosion resistance according. 240 hours salt spray tested according to EN1670.
7. Higher Fire resistance compared to the classic zamak hinges.

INDEX

Model	Maximum load capacity	Application	Hinge casing width on door side	K distance	Axis with assisted adjustment	Certifications	Page
ATOMIKA K8000	60 kg		31 mm	max 7 mm	X / Y / Z		24
ATOMIKA SLIM K8060	60 kg		24 mm	max 4 mm	X / Y / Z		26
ATOMIKA KARAKTER K8080	80 kg 100 kg		28 mm	max 4 mm	X / Y / Z		28
ATOMIKA KARAKTER K8120	120 kg		28 mm	max 4 mm	X / Y / Z		30
KUBI7 KINOX K7316	120 kg 140 kg		30 mm	max 4 mm	X / Z		32



LEGENDA

• *K distance:*

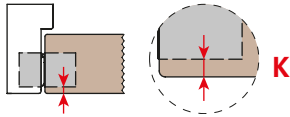

K distance is the distance between the door edge and the hinge edge.

*The **K-Max** means is the maximum K-distance that allows the correct rotation of the door from 0 ° to 180 °).*

• *Centered hinge:*

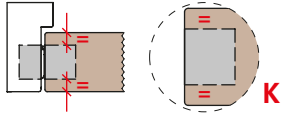

*The installation with a hinge centered on the door leaf has the advantage of making the door leaf reversible. You have a centered hinge when the **K distance** is equal to the measurement on the opposite side.*





• *Maximum load capacity:*

The maximum load capacity is referred to a door 2100 mm high, 900 mm wide and with a center to center distance 1540 mm (as the reference legislation specifies). For the measurements that differ from the indicated ones, we suggest reading the range table which you can find on each product page.

• *Axis with assisted adjustment:*

All Krona Koblenz hinges are adjustable on the 3 axes (3D): X, Y, Z. Some of these adjustments are assisted while others are manual. The index table indicates the axes with the assisted adjustment.







• *Certifications:*

-  Declaration of performance and the constancy of performance according to the European reference regulations for the product category (insights to the Certifications Chapter);
-  IFT Rosenheim laboratory which certified the conformity of the hinges to the tests necessary for the CE marking or durability tests;
-  Fire certification according to **EN 1634-1** and/or **BS476-22**;
-  Certification of conformity for the American and Canadian market according to the reference standards;
-  Certification of conformity to reference standards for the Russian market;

• *Full HD*

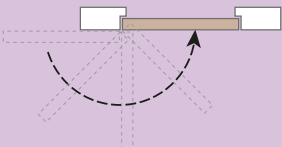

All the hinge components have the same colour.

Application			
All Krona Koblenz hinges can be installed both on the right and on the left as well as in push or pull direction depending on the desired installation			
 Door flush to the wall	 Door leaf with internal rebate	 Door leaf with external rebate	 Self closing door
 Door flush to the trim (offset hinge)	 Cladding	 Furniture	

Atomika K8000

PATENTED

MADE IN ITALY

HINGE MATERIAL Steel	LOAD CAPACITY 60 kg (n.2 hinges) 	APPLICATION Flush to the wall door 	APPLICATION Cladding max 7 mm max 7 mm
K DISTANCE K-max 7 mm	HINGE CENTERED ON THE DOOR LEAF Thk Max Thk 45 mm	OPENING ANGLE 180° 	
3D ADJUSTMENTS Z +3 / -3 X +1 / -1 Y +1 / -1	TESTED WITH DOOR CLOSER* 	FINISHING Full HD 	COVER MATERIAL Steel
NUMBER OF ROTATION AXES 7 	MAGNETIC COVER 	SUITABLE FOR kiker	Rif. report reference N° R27182-20170327 UL US LISTED

Test report

ift
ROSENHEIM

N° 18-000602-PR01 - 20/11/2018
UNI EN1191:2012 Windows and doors
Resistance to opening and closing

Internal door with hinges
mod. ATOMIKA K8000
Total door weight: 60kg

EN 1634-1

30 min.

GOST R
53307 -2009

EN 1670

Spray salt tested

240 hours

*Tested with door closer models most frequently used on the market.



Performance Series

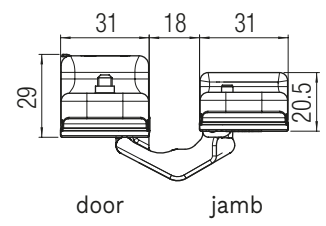
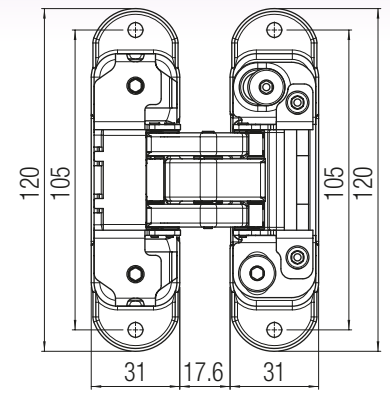
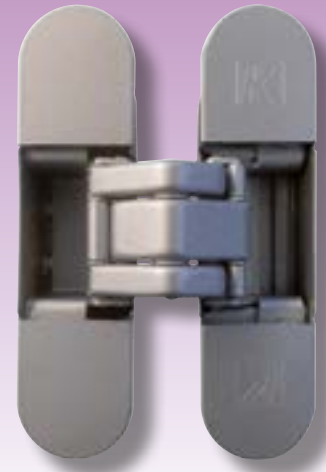

Finishing		
Colour	Item number. standard	Item number. magnetic
Polished chrome	K 8000 CL HD	K 8000 CL CM
Satin chrome	K 8000 CS HD	K 8000 CS CM
Satin nickel	K 8000 NS HD	K 8000 NS CM
Polished gold	K 8000 OL HD	K 8000 OL CM
Satin gold	K 8000 OS HD	
Bronze	K 8000 BR HD	K 8000 BR CM
Brushed bronze	K 8000 BS HD	K 8000 BS CM
Polished brass	K 8000 OTL HD	K 8000 OTL CM
White	K 8000 BI HD	K 8000 BI CM
Black	K 8000 NO HD	K 8000 NO CM

For other colours please ask Krona Koblentz for feasibility

Load capacity table (see the reading guide at page 12)

K8000 - 60 Kg - N.2 hinges												
2000	60	60	60	60	60	60	60	60	60	58	56	
1950	60	60	60	60	60	60	60	60	60	59	56	
1900	60	60	60	60	60	60	60	60	60	57	55	
1850	60	60	60	60	60	60	60	60	60	58	56	
1800	60	60	60	60	60	60	60	59	56	54	52	
1750	60	60	60	60	60	60	60	57	55	53	51	
1700	60	60	60	60	60	58	56	53	51	49	47	
1650	60	60	60	60	60	57	54	52	50	48	46	
1600	60	60	60	60	58	55	52	50	48	46	44	
1550	60	60	60	59	56	53	51	49	47	45	43	
1500	60	60	60	57	54	52	49	47	45	43	42	
1450	60	60	58	55	52	50	48	45	44	42	40	
1540	60											
	926	700	800	900	950	1000	1050	1100	1150	1200	1250	1300
		Door leaf width (mm)**										

Hinge spacing (mm)**

Milling door/jamb

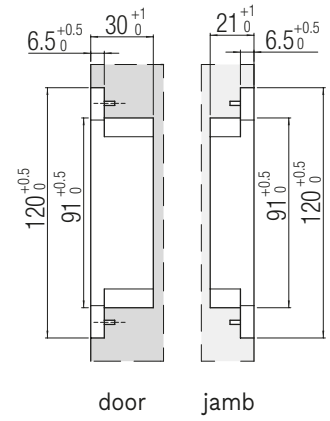

Test specifications:

- 2 hinges: Hinge spacing 1540 mm - Door leaf width 926 mm - Opening angle 0°-90°.

**With door dimensions and max opening angle different from the tested configuration and/or with the application of other devices such as, for example, door closers/bumpers/emergency handle/dropdown seal/etc. refer to the "Installation Examples". Please note that testing for these configurations is under customer's responsibility. We specify that the combinations are the result of interpolation and not of real tests, which remain under the customer's responsibility.

Standard application

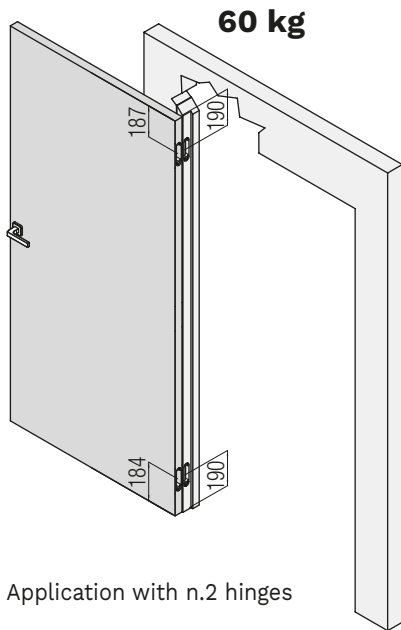

Application with n.2 hinges

Installation of Hinge centered on the door leaf

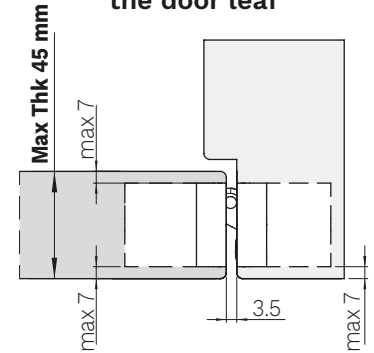

Installation of Hinge NOT centered on the door leaf

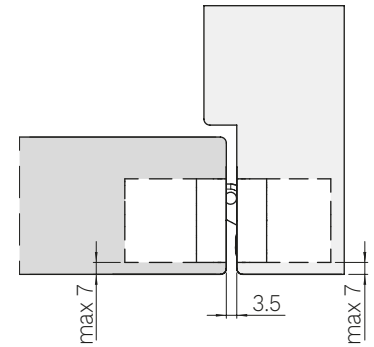

Fixing screws included

The hinge fixing is ensured by using the **fixing screws** indicated in the hinge assembly instructions.



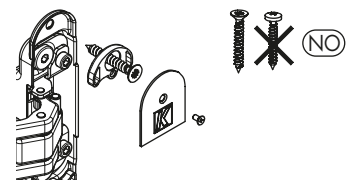





N.B.: for hinge K8000, the countersunk screws and the cover *kit with screw* must always be installed together. The countersunk screws to use are indicated in the assembly instructions.

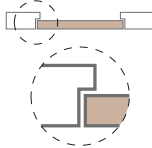
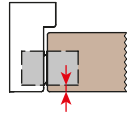
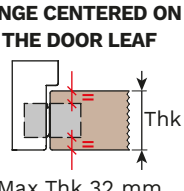
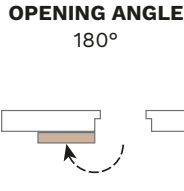
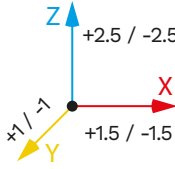
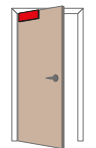

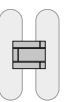
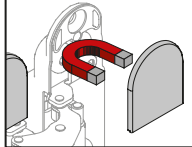
Atomika SLIM K8060

PATENTED

MADE IN ITALY

HINGE MATERIAL Steel	LOAD CAPACITY 60 kg (n.2 hinges) 	APPLICATION Flush to the wall door 	K DISTANCE  K-max 4 mm
HINGE CENTERED ON THE DOOR LEAF  Max Thk 32 mm	OPENING ANGLE 180° 	3D ADJUSTMENTS  Z: +2.5 / -2.5 X: +1.5 / -1.5 Y: x1 / -1	
TESTED WITH DOOR CLOSER* 	FINISHING Full HD 	COVER MATERIAL Steel 	NUMBER OF ROTATION AXES 7 
MAGNETIC COVER 	SUITABLE FOR 	Test report  N° 18-000602-PR02 - 20/11/2018 UNI EN1191:2012 Windows and doors Resistance to opening and closing Internal door with hinges mod. ATOMIKA K8060 Slim Total door weight: 60kg	
Rif. report reference N° R27182-20170327 	EN 1634-1  30 min.	EN 1634-1  45 min.	EN 1670 Spray salt tested 240 hours

*Tested with door closer models most frequently used on the market.



Product details:



Performance Series

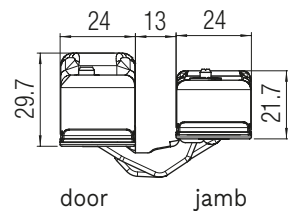
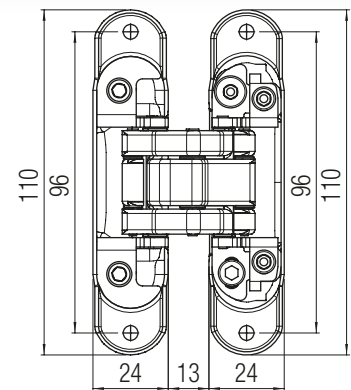

Finishing

Colour	Item number. standard	Item number. magnetic
Polished chrome	K 8060 CL HD	K 8060 CL CM
Satin chrome	K 8060 CS HD	K 8060 CS CM
Satin nickel	K 8060 NS HD	K 8060 NS CM
Polished gold	K 8060 OL HD	K 8060 OL CM
Satin gold	K 8060 OS HD	K 8060 OS CM
Bronze	K 8060 BR HD	K 8060 BR CM
Brushed bronze	K 8060 BS HD	K 8060 BS CM
Polished brass	K 8060 OTL HD	K 8060 OTL CM
White	K 8060 BI HD	K 8060 BI CM
Black	K 8060 NO HD	K 8060 NO CM

For other colours please ask Krona Koblenz for feasibility



Load capacity table (see the reading guide at page 12)

K8060 - 60 Kg - N.2 hinges												
Hinge spacing (mm)**	2000	60	60	60	60	60	60	60	60	60	58	56
	1950	60	60	60	60	60	60	60	60	60	59	56
	1900	60	60	60	60	60	60	60	60	60	57	55
	1850	60	60	60	60	60	60	60	60	60	58	56
	1800	60	60	60	60	60	60	59	56	54	52	50
	1750	60	60	60	60	60	60	57	55	53	51	49
	1700	60	60	60	60	60	58	56	53	51	49	47
	1650	60	60	60	60	60	57	54	52	50	48	46
	1600	60	60	60	60	58	55	52	50	48	46	44
	1550	60	60	60	59	56	53	51	49	47	45	43
	1500	60	60	60	57	54	52	49	47	45	43	42
1450	60	60	58	55	52	50	48	45	44	42	40	
1540	60											
	926	700	800	900	950	1000	1050	1100	1150	1200	1250	1300
Door leaf width (mm)**												

Test specifications:

- 2 hinges: Hinge spacing 1540 mm - Door leaf width 926 mm - Opening angle 0°-90°.

**With door dimensions and max opening angle different from the tested configuration and/or with the application of other devices such as, for example, door closers/bumpers/emergency handle/dropdown seal/etc. refer to the "Installation Examples". Please note that testing for these configurations is under customer's responsibility. We specify that the combinations are the result of interpolation and not of real tests, which remain under the customer's responsibility.

Standard application

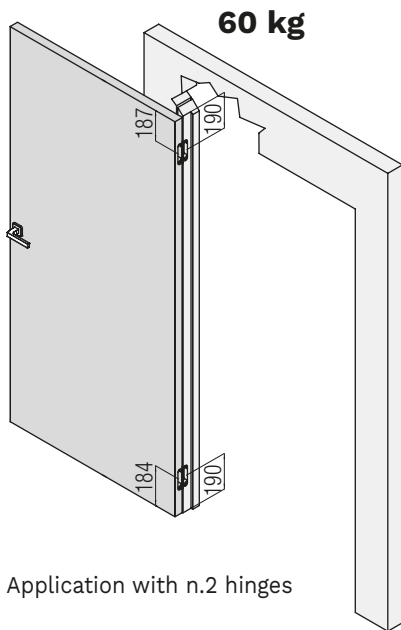

Application with n.2 hinges

Milling door/jamb

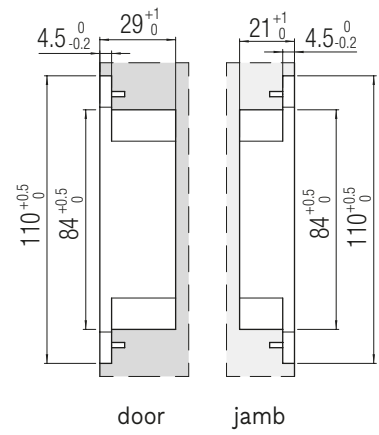

door jamb

Installation of Hinge centered on the door leaf

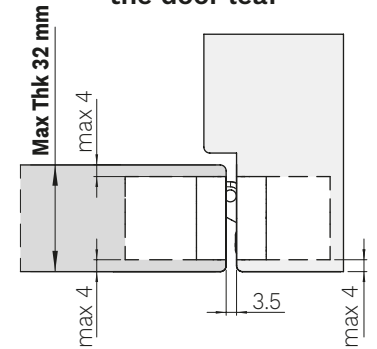

Installation of Hinge NOT centered on the door leaf

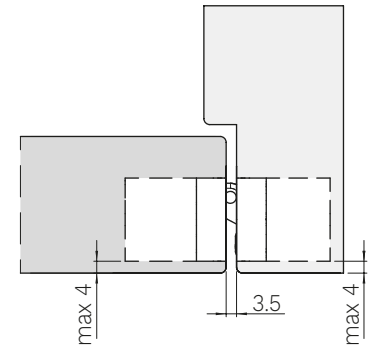

 **Fixing screws included**
The hinge fixing is ensured by using the **fixing screws** indicated in the hinge assembly instructions.

MADE IN ITALY

HINGE MATERIAL Steel	LOAD CAPACITY 80 kg (n.2 hinges) 100 kg (n.3 hinges) 	APPLICATION Flush to the wall door 	K DISTANCE K-max 4 mm
HINGE CENTERED ON THE DOOR LEAF Max Thk 36 mm	OPENING ANGLE 180° 	3D ADJUSTMENTS Z +3 / -3 X +3 / -2 Y +1 / -1	TESTED WITH DOOR CLOSER*
FINISHING Full HD 	INTERCHANGEABLE WITH: K8120 / K5080 	COVER MATERIAL Steel Kit of cover with screws (optional)	NUMBER OF ROTATION AXES 7
MAGNETIC COVER 	SUITABLE FOR kiker	EN 1634-1 BS476-22 120 min.	EN 1634-1 60 min.

Product Quality

N° 19-000093-PR01 - 18/06/2019
Multi-axis, concealed hinges
EAD 020001-01-0405
Reg.-N°: 9000283

Rif. report reference
N° R27182-20170327

EN 1634-1
BS476-22

120 min.

CE

Krona Koblenz SpA Via Romero, 1 47853 Coriano	24
0757 ETA-20/0491 DAP/DAP-NI: 006/ITACPR/2024-04-18 HINGES DO NOT CONTAIN HARMFUL SUBSTANCES	3 7 4 1 1 4 0 11 ATOMIKA K8080

<https://www.kronakoblenz.com/certificazioni/pdf/ce-certificate-k8080-koblenz.pdf>

EN 1634-1

60 min.

EN 1670
Spray salt tested
240 hours

*Tested with door closer models most frequently used on the market.



Performance Series

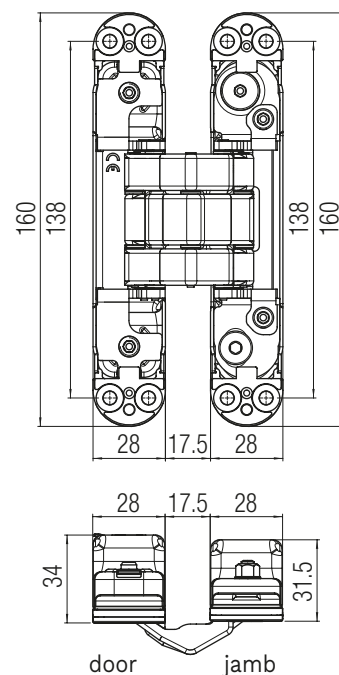
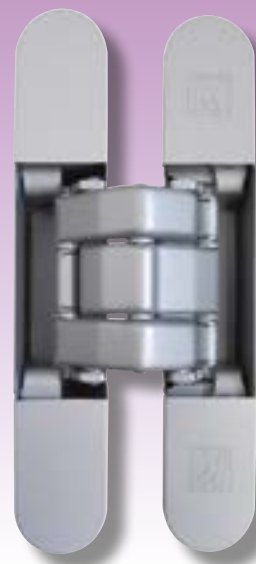

Colour	Finishing	
	Item number. standard	Item number. magnetic
Polished chrome	K 8080 CL	K 8080 CL CM
Satin chrome	K 8080 CS	K 8080 CS CM
Satin nickel	K 8080 NS	K 8080 NS CM
Polished gold	K 8080 OL	K 8080 OL CM
Satin gold	K 8080 OS	K 8080 OS CM
Bronze	K 8080 BR	K 8080 BR CM
Brushed bronze	K 8080 BS	K 8080 BS CM
Polished brass	K 8080 OTL	K 8080 OTL CM
White	K 8080 BI	K 8080 BI CM
Black	K 8080 NO	K 8080 NO CM

For other colours please ask Krona Koblenz for feasibility

Load capacity table (see the reading guide at page 12)

K8080 - 80 Kg - N.2 hinges												
2000	80	80	80	80	80	80	80	80	80	80	77	74
1950	80	80	80	80	80	80	80	80	80	78	75	72
1900	80	80	80	80	80	80	80	79	76	73	70	68
1850	80	80	80	80	80	80	80	77	74	71	68	67
1800	80	80	80	80	80	80	79	75	72	69	67	65
1750	80	80	80	80	80	80	77	73	70	67	65	63
1700	80	80	80	80	80	78	74	71	68	65	63	61
1650	80	80	80	80	79	76	72	69	66	63	61	59
1600	80	80	80	80	77	73	70	67	64	62	59	57
1550	80	80	80	78	75	71	68	65	62	60	57	56
1500	80	80	80	76	72	69	66	63	60	58	56	54
1450	80	80	78	73	70	66	63	61	58	56	54	
1540	80											
	926	700	800	900	950	1000	1050	1100	1150	1200	1250	1300
		Door leaf width (mm)**										

K8080 - 100 Kg - N.3 hinges												
2000	100	100	100	100	100	99	95	90	87	83	80	78
1950	100	100	100	100	100	97	92	88	85	81	78	76
1900	100	100	100	100	99	94	90	86	82	79	76	74
1850	100	100	100	100	96	92	87	84	80	77	74	72
1800	100	100	100	99	94	89	85	81	78	75	72	70
1750	100	100	100	96	91	87	83	79	76	73	70	68
1700	100	100	98	93	88	84	80	77	74	71	68	66
1650	100	100	95	90	86	82	78	75	72	69	66	64
1600	100	100	92	88	83	79	76	72	69	67	64	62
1550	100	100	90	85	81	77	73	70	67	65	62	60
1500	100	98	87	82	78	74	71	68	65	62	60	58
1450	100	94	84	79	75	72	69	66	63	60	58	56
1730	100											
	900	700	800	900	950	1000	1050	1100	1150	1200	1250	1300
		Door leaf width (mm)**										

Milling door/jamb

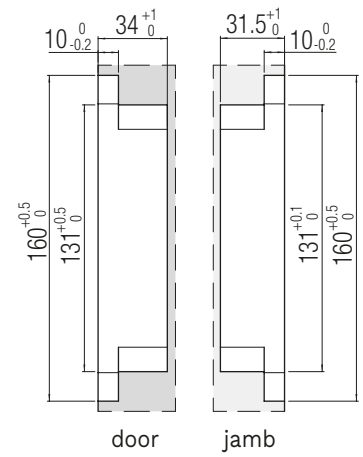

Installation of Hinge centered on the door leaf

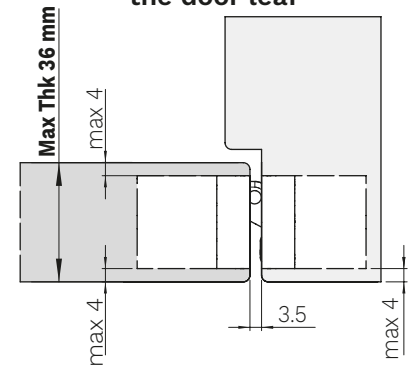

Installation of Hinge NOT centered on the door leaf

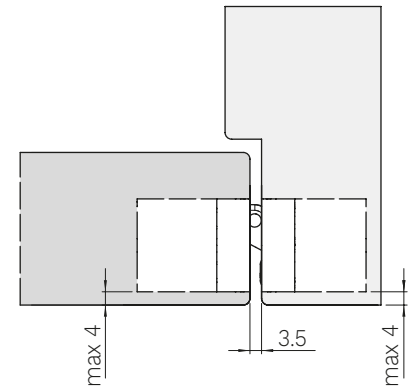

Test specifications:

- 2 hinges: Hinge spacing 1540 mm - Door leaf width 926 mm - Opening angle 0°-90°.
- 3 hinges: Hinge spacing 1730 mm - Door leaf width 900 mm - Opening angle 0°-90°.

**With door dimensions and max opening angle different from the tested configuration and/or with the application of other devices such as, for example, door closers/bumpers/emergency handle/dropdown seal/etc. refer to the "Installation Examples". Please note that testing for these configurations is under customer's responsibility. We specify that the combinations are the result of interpolation and not of real tests, which remain under the customer's responsibility.

Standard application

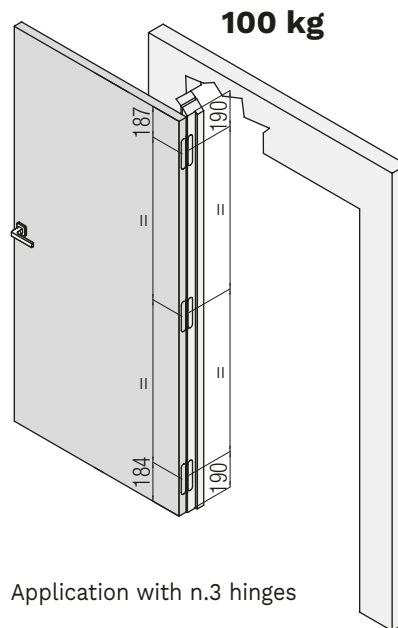
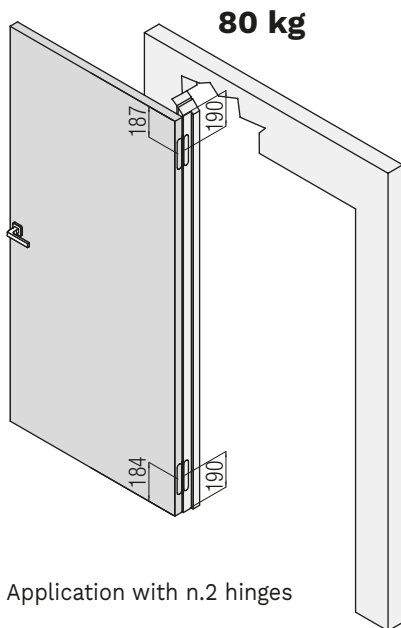

Application with n.2 hinges







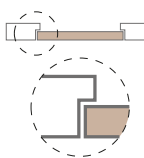
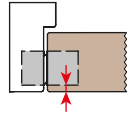
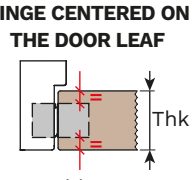
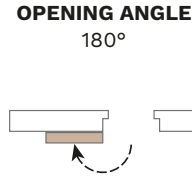
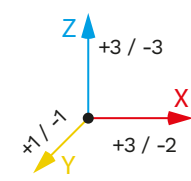

Application with n.3 hinges

Fixing screws included
The hinge fixing is ensured by using the **fixing screws and adapters** indicated in the hinge assembly instructions.

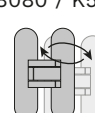
Atomila KARAKTER K8120

PATENTED

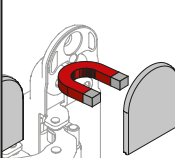
MADE IN ITALY

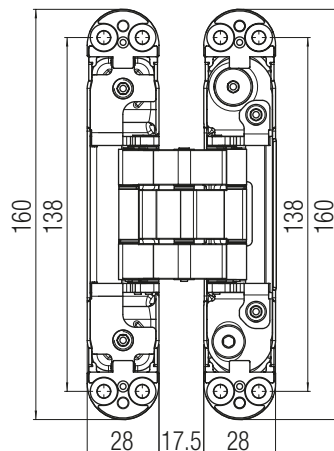
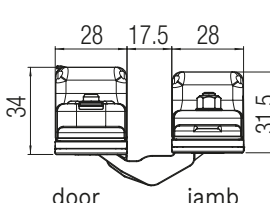
<p>HINGE MATERIAL</p> <p>Casing: Steel Adjustment body: Steel Connecting rods: Steel AISI 316</p>	<p>LOAD CAPACITY 120 kg (n.2/3 hinges)</p> 	<p>APPLICATION Flush to the wall door</p> 	<p>K DISTANCE</p>  <p>K-max 4 mm</p>
<p>HINGE CENTERED ON THE DOOR LEAF</p>  <p>Max Thk 36 mm</p>	<p>OPENING ANGLE 180°</p> 	<p>3D ADJUSTMENTS</p>  <p>Z +3 / -3 X +3 / -2 Y +1 / -1</p>	<p>FINISHING Full HD</p> 
<p>INTERCHANGEABLE WITH: K8080 / K5080</p> 	<p>COVER MATERIAL Steel</p>  <p>Kit of cover with screws (optional)</p>	<p>BURGLAR-PROOF DOOR</p> 	<p>NUMBER OF ROTATION AXES 7</p> 
<p>MAGNETIC COVER</p> 	<p>SUITABLE FOR</p> <p>kiker</p>	<p>Suitable for high opening and closing environment</p>	<p>Rif. report reference N° R27182-20170327</p> 
<p>BS476-22</p>  <p>45 min.</p>	<p>EN 1670</p> <p>Spray salt tested</p> <p>240 hours</p>	  <p>door jamb</p>	

Performance Series

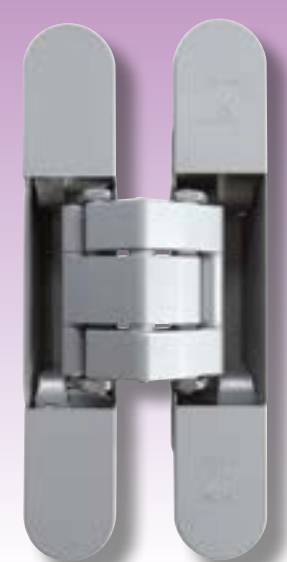

Performance Series

Classic Series

Finishes

Finishing		
Colour	Item number. standard	Item number. magnetic
Satin chrome	K 8120 CS	K 8120 CS CM
Satin nickel		K 8120 NS CM
Black	K 8120 NO	K 8120 NO CM

For other colours please ask Krona Koblenz for feasibility

Accessories

Warnings



Product details:



Load capacity table (see the reading guide at page 12)

K8120 - 120 Kg - N.2/3 hinges												
Hinge spacing (mm)**	2000	120	120	120	120	120	120	120	120	120	115	111
	1950	120	120	120	120	120	120	120	120	117	113	108
	1900	120	120	120	120	120	120	120	119	114	110	105
	1850	120	120	120	120	120	120	120	120	116	111	107
	1800	120	120	120	120	120	120	118	113	108	104	100
	1750	120	120	120	120	120	120	115	110	105	101	97
	1700	120	120	120	120	120	117	112	107	102	98	94
	1650	120	120	120	120	119	113	108	104	99	95	92
	1600	120	120	120	120	115	110	105	100	96	92	89
	1550	120	120	120	118	112	107	102	97	93	89	86
	1500	120	120	120	114	108	103	98	94	90	87	83
	1450	120	120	116	110	105	100	95	91	87	84	80
1540	120											
	926	700	800	900	950	1000	1050	1100	1150	1200	1250	1300
		Door leaf width (mm)**										

Test specifications:

- 2/3 hinges: Hinge spacing 1540 mm - Door leaf width 926 mm - Opening angle 0°-90°.

**With door dimensions and max opening angle different from the tested configuration and/or with the application of other devices such as, for example, door closers/bumpers/emergency handle/dropdown seal/etc. refer to the "Installation Examples". Please note that testing for these configurations is under customer's responsibility. We specify that the combinations are the result of interpolation and not of real tests, which remain under the customer's responsibility.

Standard application

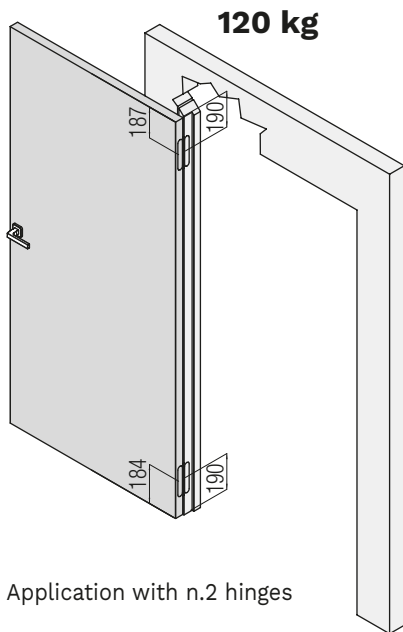

Application with n.2 hinges

Milling door/jamb

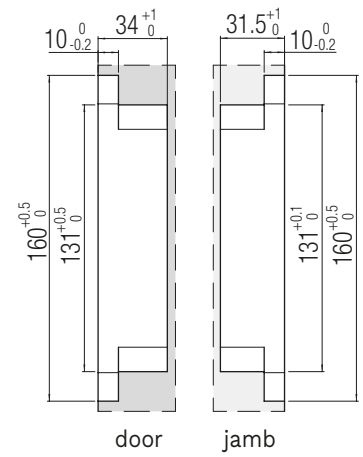

Installation of Hinge centered on the door leaf

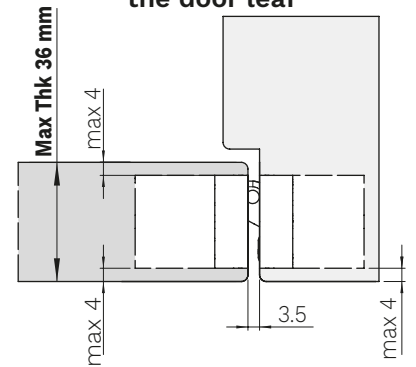

Installation of Hinge NOT centered on the door leaf

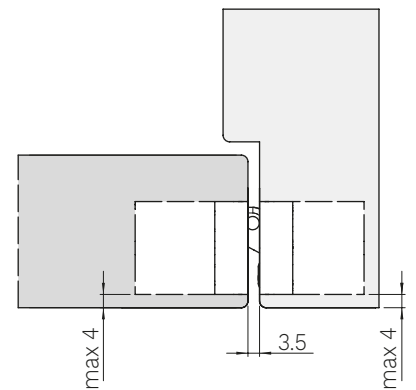

Fixing screws included

The hinge fixing is ensured by using the **fixing screws** indicated in the hinge assembly instructions.

MADE IN ITALY

HINGE MATERIAL Steel AISI 316	LOAD CAPACITY 120 kg (n.2 hinges) 140 kg (n.3 hinges) 	APPLICATION Flush to the wall door 	K DISTANCE K-max 4 mm
HINGE CENTERED ON THE DOOR LEAF Max Thk 38 mm	OPENING ANGLE 180° 	3D ADJUSTMENTS Z: +3 / -3 X: +2 / -2 Y: x1 / -1	
INTERCHANGEABLE WITH: K7080 	COVER MATERIAL Steel AISI 316 Cover with screws	BURGLAR-PROOF DOOR 	NUMBER OF ROTATION AXES 7
SUITABLE FOR kiker	Test report N° 17-001637-PR02 - 26/04/2018 EAD 020001-01-0405 : 2017 Multi-axis concealed hinges Door with two hinges mod. KINOX K7316 Total door weight: 120kg Suitable for high opening and closing environment		
Rif. report reference N° R27182-20130522 	EN 1634-1 BS476-22 120 min.	EN 1634-1 180 min.	EN 1670 Spray salt tested 240 hours

Performance Series

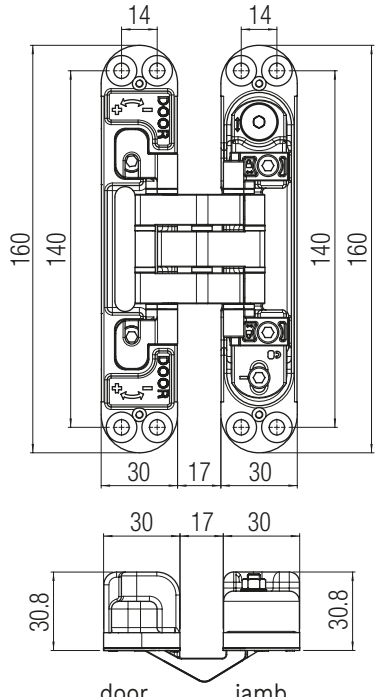
Technical drawing dimensions: 160, 140, 140, 160, 30, 17, 30, 30, 17, 30, 30.8, 30.8, door, jamb.

Finishing

Colour	Item number.
Satin steel	K 7316 AS

For other colours please ask Krona Koblenz for feasibility



Load capacity table (see the reading guide at page 12)

K7316 - 120 Kg - N.2 hinges												
2000	120	120	120	120	120	120	120	120	120	115	111	
1950	120	120	120	120	120	120	120	120	120	117	108	
1900	120	120	120	120	120	120	120	120	119	114	105	
1850	120	120	120	120	120	120	120	120	116	111	103	
1800	120	120	120	120	120	120	118	113	108	104	100	
1750	120	120	120	120	120	120	115	110	105	101	97	
1700	120	120	120	120	120	117	112	107	102	98	94	
1650	120	120	120	120	119	113	108	104	99	95	92	
1600	120	120	120	120	115	110	105	100	96	92	89	
1550	120	120	120	118	112	107	102	97	93	89	86	
1500	120	120	120	114	108	103	98	94	90	87	83	
1450	120	120	116	110	105	100	95	91	87	84	80	
1540	120											
	926	700	800	900	950	1000	1050	1100	1150	1200	1250	1300
Door leaf width (mm)**												

K7316 - 140 Kg - N.3 hinges												
2000	140	140	140	140	140	139	132	127	121	117	112	
1950	140	140	140	140	140	135	129	123	118	114	109	
1900	140	140	140	140	138	132	126	120	115	111	106	
1850	140	140	140	140	135	128	122	117	112	108	104	
1800	140	140	140	138	131	125	119	114	109	105	101	
1750	140	140	140	134	127	121	116	111	106	102	98	
1700	140	140	138	130	124	118	113	108	103	99	95	
1650	140	140	134	126	120	114	109	104	100	96	92	
1600	140	140	129	123	117	111	106	101	97	93	90	
1550	140	140	125	119	113	108	103	98	94	90	87	
1500	140	137	121	115	109	104	99	95	91	87	84	
1450	140	132	117	111	106	101	96	92	88	84	81	
1730	140											
	900	700	800	900	950	1000	1050	1100	1150	1200	1250	1300
Door leaf width (mm)**												

Test specifications:

- 2 hinges: Hinge spacing 1540 mm - Door leaf width 926 mm - Opening angle 0°-90°.
- 3 hinges: Hinge spacing 1730 mm - Door leaf width 900 mm - Opening angle 0°-90°.

**With door dimensions and max opening angle different from the tested configuration and/or with the application of other devices such as, for example, door closers/bumpers/emergency handle/dropdown seal/etc. refer to the "Installation Examples". Please note that testing for these configurations is under customer's responsibility. We specify that the combinations are the result of interpolation and not of real tests, which remain under the customer's responsibility.

Standard application

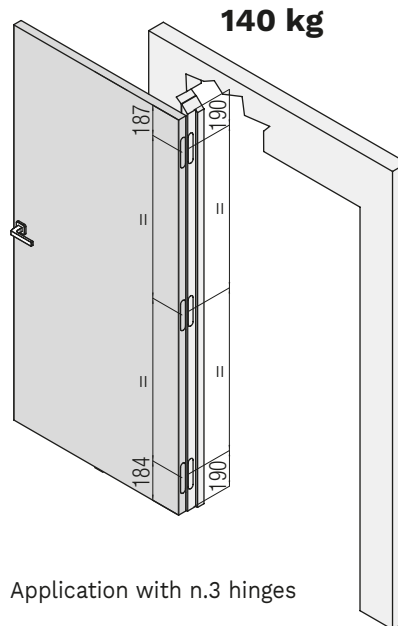
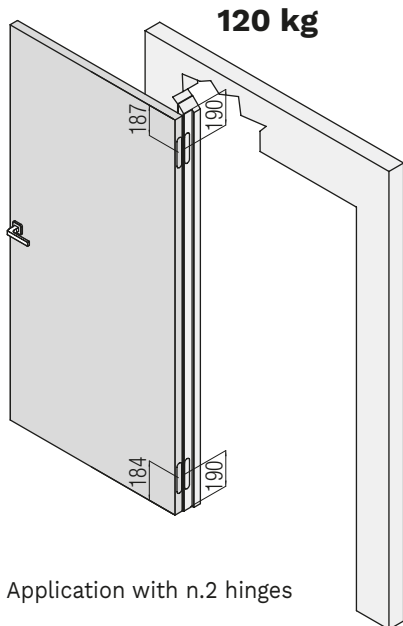

Milling door/jamb

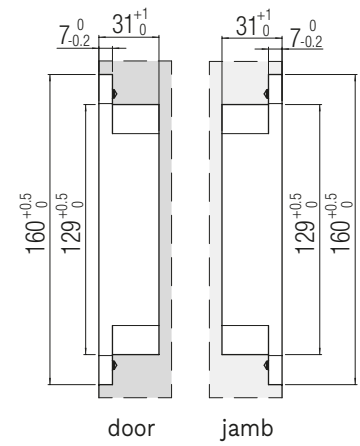

Installation of Hinge centered on the door leaf

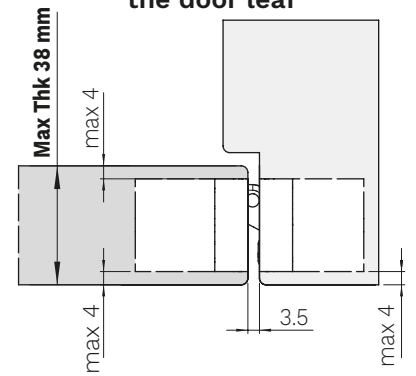

Installation of Hinge NOT centered on the door leaf

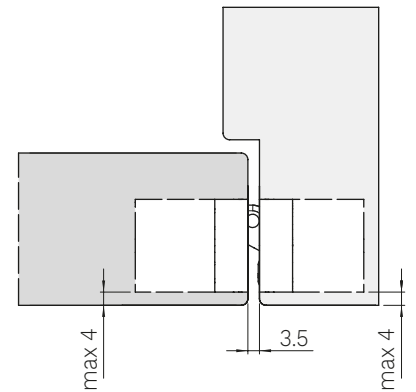

















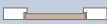

Fixing screws included
The hinge fixing is ensured by using the **fixing screws** indicated in the hinge assembly instructions.

The hinges of this series are called **"Hybrid"** because they are **made using both Zamak and Steel components and acetal plastic** for some models only.

The decision to combine different materials in single components has made it possible to unite the **high performance** of models made of **zamak** with high competitiveness on the market of the steel.

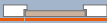
The geometry of the **connecting rods with 5 fulcrums** guarantees their **excellent solidity**.

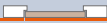
INDEX

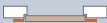
Model	Maximum load capacity	Application	Hinge casing width on door side	K distance	Axis with assisted adjustment	Certifications	Page
KOMBI HYBRID K1019	40 kg		24 mm	max 5 mm	X / Y		36
KOMBI HYBRID K1019 26	40 kg		26 mm	max 5 mm	X / Y		38
KOMBI HYBRID K1019 30	40 kg		30 mm	max 5 mm	X / Y		40
KOMBI HYBRID K1019 34	40 kg		34 mm	max 5 mm	X / Y		42
KOMBI HYBRID K1060	60 kg		24 mm	max 5 mm	X / Y		44
KOMBI HYBRID K1060 26	60 kg		26 mm	max 5 mm	X / Y		46
KOMBI HYBRID K1060 30	60 kg		30 mm	max 5 mm	X / Y		48
KOMBI HYBRID K1060 34	60 kg		34 mm	max 5 mm	X / Y		50
KUBICA K2460	60 kg		18 mm	max 4 mm	X		52
KUBICA K6360 38	60 kg		30 mm	max 4 mm	X		54
KUBICA K6360 45	60 kg		37 mm	max 4 mm	X		56
KUBICA K2760	60 kg		27 mm	max 9 mm	X		58
KUBICA K2780	80 kg		27 mm	max 9 mm	X		60
KUBICA K6380 38	80 kg		30 mm	max 4 mm	X		62
KUBICA K6380 45	80 kg		37 mm	max 4 mm	X		64



LEGENDA

• *K distance:*

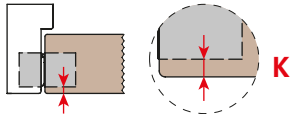

K distance is the distance between the door edge and the hinge edge.

*The **K-Max** means is the maximum K-distance that allows the correct rotation of the door from 0 ° to 180 °).*

• *Centered hinge:*

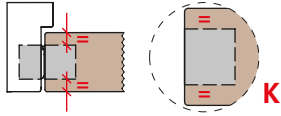

*The installation with a hinge centered on the door leaf has the advantage of making the door leaf reversible. You have a centered hinge when the **K distance** is equal to the measurement on the opposite side.*





• *Maximum load capacity:*

The maximum load capacity is referred to a door 2100 mm high, 900 mm wide and with a center to center distance 1540 mm (as the reference legislation specifies). For the measurements that differ from the indicated ones, we suggest reading the range table which you can find on each product page.

• *Axis with assisted adjustment:*

All Krona Koblenz hinges are adjustable on the 3 axes (3D): X, Y, Z. Some of these adjustments are assisted while others are manual. The index table indicates the axes with the assisted adjustment.





• *Certifications:*

-  Declaration of performance and the constancy of performance according to the European reference regulations for the product category (insights to the Certifications Chapter);
-  IFT Rosenheim laboratory which certified the conformity of the hinges to the tests necessary for the CE marking or durability tests;
-  Fire certification according to **EN 1634-1** and/or **BS476-22**;
-  Certification of conformity for the American and Canadian market according to the reference standards;
-  Certification of conformity to reference standards for the Russian market;

• *Full HD*

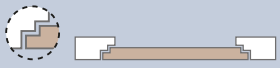
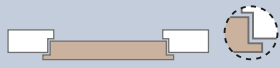
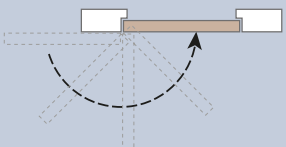

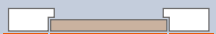



All the hinge components have the same colour.

Application			
All Krona Koblenz hinges can be installed both on the right and on the left as well as in push or pull direction depending on the desired installation			
 Door flush to the wall	 Door leaf with internal rebate	 Door leaf with external rebate	 Self closing door
 Door flush to the trim (offset hinge)	 Cladding	 Furniture	

Kombi HYBRID K1019 HYBRID

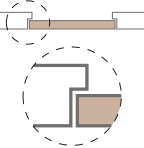
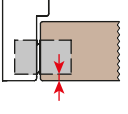
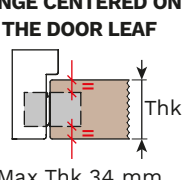
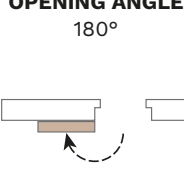
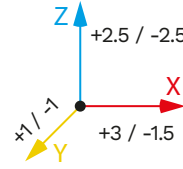
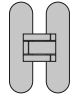
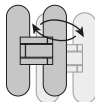
MADE IN ITALY

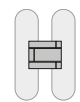
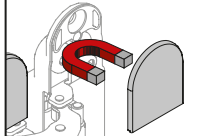
PATENTED

<p>HINGE MATERIAL</p> <p>Casing: Steel Adjustment body: Acetal plastic Connecting rods: Zamak</p>	<p>LOAD CAPACITY 40 kg (n.2 hinges)</p> 	<p>APPLICATION Flush to the wall door</p> 	<p>K DISTANCE</p>  <p>K-max 5 mm</p>
<p>HINGE CENTERED ON THE DOOR LEAF</p>  <p>Max Thk 34 mm</p>	<p>OPENING ANGLE 180°</p> 	<p>3D ADJUSTMENTS</p>  <p>Z: +2.5 / -2.5 X: +3 / -1.5 Y: +1 / -1</p>	
<p>FINISHING Full HD</p> 	<p>INTERCHANGEABLE WITH: K1060</p> 	<p>COVER MATERIAL Steel</p> 	<p>NUMBER OF ROTATION AXES 5</p> 
<p>MAGNETIC COVER</p> 	<p>SUITABLE FOR</p> <p>kiker</p>	<p>Product Quality</p> <p>Multi-axis, concealed hinges EAD 020001-01-0405</p> <p>Reg.-N°: 9000283</p> 	

Evolution Series

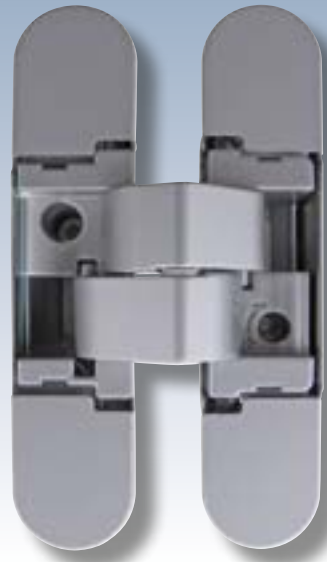
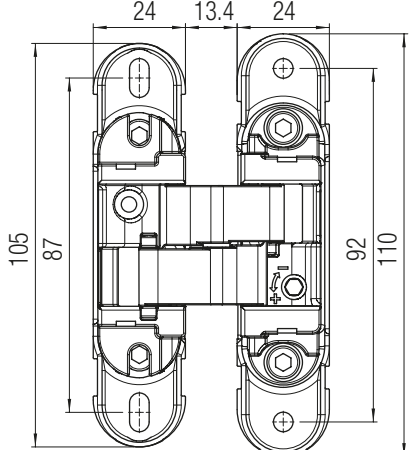
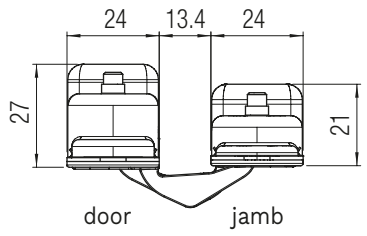
door jamb

Finishing		
Colour	Item number. standard	Item number. magnetic
Polished chrome	K 1019 CL HD	K 1019 CL CM
Satin chrome	K 1019 CS HD	K 1019 CS CM
Satin nickel	K 1019 NS HD	K 1019 NS CM
Polished gold	K 1019 OL HD	K 1019 OL CM
Satin gold	K 1019 OS HD	K 1019 OS CM
Bronze	K 1019 BR HD	K 1019 BR CM
White	K 1019 BI HD	K 1019 BI CM
Black	K 1019 NO HD	K 1019 NO CM

For other colours please ask Krona Koblenz for feasibility



Load capacity table (see the reading guide at page 12)

K1019 - 40 Kg - N.2 hinges												
Hinge spacing (mm)**	2000	40	40	40	40	40	40	40	40	40	38	37
	1950	40	40	40	40	40	40	40	40	39	38	36
	1900	40	40	40	40	40	40	40	40	38	37	35
	1850	40	40	40	40	40	40	40	40	39	37	34
	1800	40	40	40	40	40	40	39	38	36	35	33
	1750	40	40	40	40	40	40	38	37	35	34	32
	1700	40	40	40	40	40	39	37	36	34	33	31
	1650	40	40	40	40	40	38	36	35	33	32	31
	1600	40	40	40	40	39	38	37	35	33	32	30
	1550	40	40	40	39	37	36	34	32	31	30	29
	1500	40	40	40	38	36	34	33	31	30	29	28
1450	40	40	39	37	35	33	32	30	29	28	27	
1540	40											
	926	700	800	900	950	1000	1050	1100	1150	1200	1250	1300
		Door leaf width (mm)**										

Test specifications:

- 2 hinges: Hinge spacing 1540 mm - Door leaf width 926 mm - Opening angle 0°-90°.

**With door dimensions and max opening angle different from the tested configuration and/or with the application of other devices such as, for example, door closers/bumpers/emergency handle/dropdown seal/etc. refer to the "Installation Examples". Please note that testing for these configurations is under customer's responsibility. We specify that the combinations are the result of interpolation and not of real tests, which remain under the customer's responsibility.

Standard application

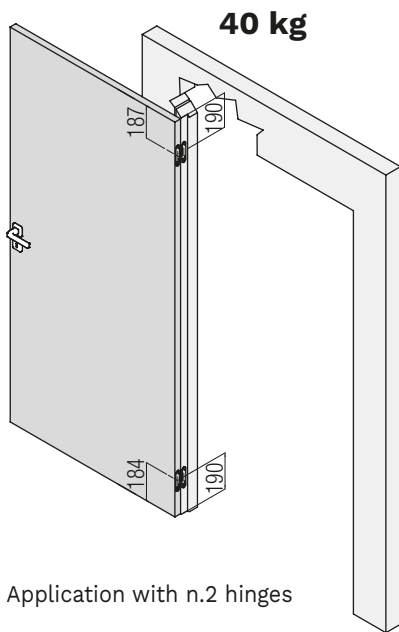

Application with n.2 hinges

Milling door/jamb

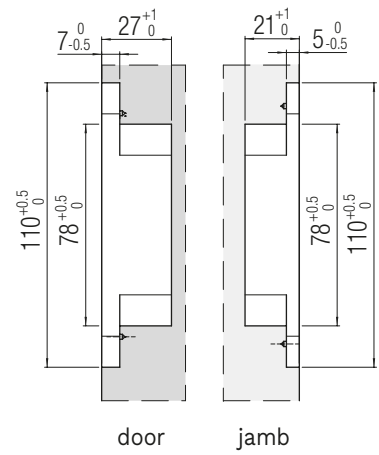

Installation of Hinge centered on the door leaf

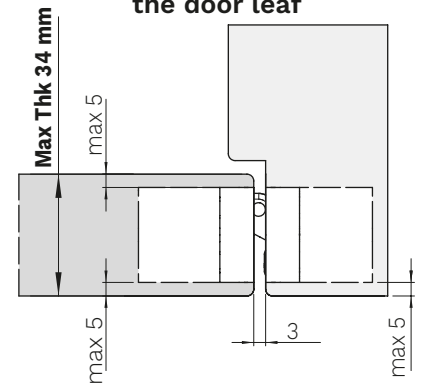

Installation of Hinge NOT centered on the door leaf

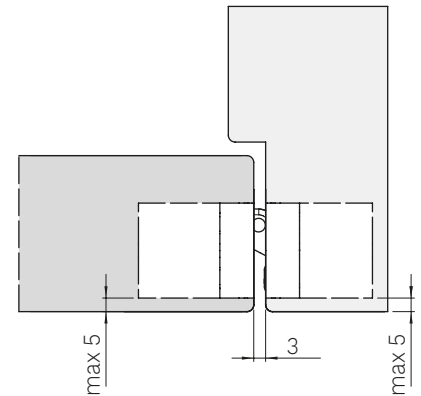



 **Fixing screws included**
The hinge fixing is ensured by using the **fixing screws** indicated in the hinge assembly instructions.

Kombi HYBRID K1019 26 HYBRID

MADE IN ITALY

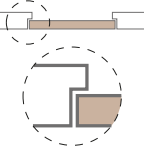
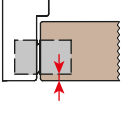
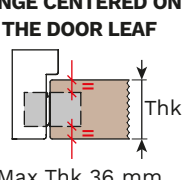
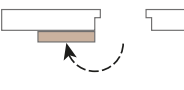
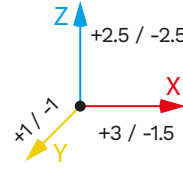
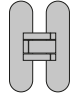
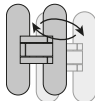
PATENTED

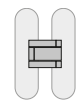
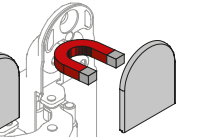
<p>HINGE MATERIAL</p> <p>Casing: Steel Adjustment body: Acetal plastic Connecting rods: Zamak</p>	<p>LOAD CAPACITY 40 kg (n.2 hinges)</p> 	<p>APPLICATION Flush to the wall door</p> 	<p>K DISTANCE</p>  <p>K-max 5 mm</p>
<p>HINGE CENTERED ON THE DOOR LEAF</p>  <p>Max Thk 36 mm</p>	<p>OPENING ANGLE 180°</p> 	<p>3D ADJUSTMENTS</p>  <p>Z: +2.5 / -2.5 X: +3 / -1.5 Y: +1 / -1</p>	
<p>FINISHING Full HD</p> 	<p>INTERCHANGEABLE WITH: K1060 26</p> 	<p>COVER MATERIAL Steel</p> 	<p>NUMBER OF ROTATION AXES 5</p> 
<p>MAGNETIC COVER</p> 	<p>SUITABLE FOR</p> <p>kiker</p>		

Evolution Series

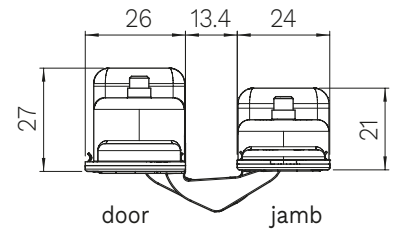
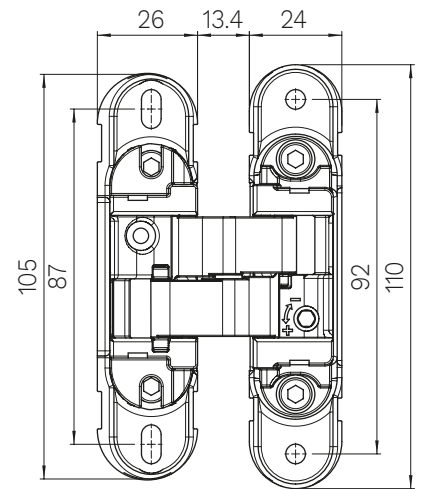
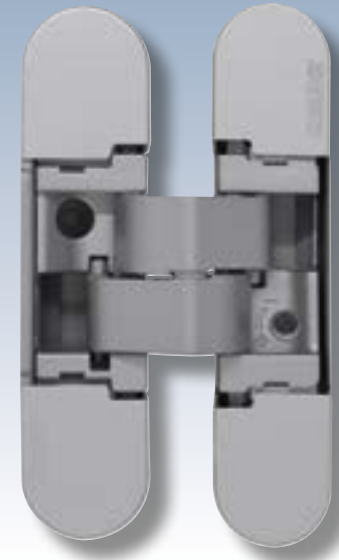

Product details:



Finishing		
Colour	Item number. standard	Item number. magnetic
Polished chrome	K 1019 26 CL	
Satin chrome	K 1019 26 CS	K 1019 26 CS CM
Satin nickel	K 1019 26 NS	
Polished gold	K 1019 26 OL	
Satin gold	K 1019 26 OS	
Bronze	K 1019 26 BR	
White	K 1019 26 BI	
Black	K 1019 26 NO	

For other colours please ask Krona Koblenz for feasibility



Load capacity table (see the reading guide at page 12)

K1019 26 - 40 Kg - N.2 hinges												
Hinge spacing (mm)**	2000	40	40	40	40	40	40	40	40	40	38	37
	1950	40	40	40	40	40	40	40	40	39	38	36
	1900	40	40	40	40	40	40	40	40	38	37	35
	1850	40	40	40	40	40	40	40	40	39	37	34
	1800	40	40	40	40	40	40	39	38	36	35	33
	1750	40	40	40	40	40	40	38	37	35	34	32
	1700	40	40	40	40	40	39	37	36	34	33	31
	1650	40	40	40	40	40	38	36	35	33	32	31
	1600	40	40	40	40	39	37	35	33	32	31	30
	1550	40	40	40	39	37	36	34	32	31	30	29
	1500	40	40	40	38	36	34	33	31	30	29	28
1450	40	40	39	37	35	33	32	30	29	28	27	
1540	40											
	926	700	800	900	950	1000	1050	1100	1150	1200	1250	1300
		Door leaf width (mm)**										

Test specifications:

- 2 hinges: Hinge spacing 1540 mm - Door leaf width 926 mm - Opening angle 0°-90°.

**With door dimensions and max opening angle different from the tested configuration and/or with the application of other devices such as, for example, door closers/bumpers/emergency handle/dropdown seal/etc. refer to the "Installation Examples". Please note that testing for these configurations is under customer's responsibility. We specify that the combinations are the result of interpolation and not of real tests, which remain under the customer's responsibility.

Standard application

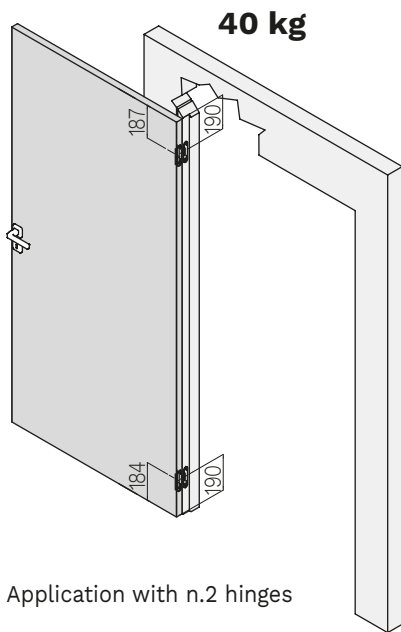

Application with n.2 hinges

Milling door/jamb

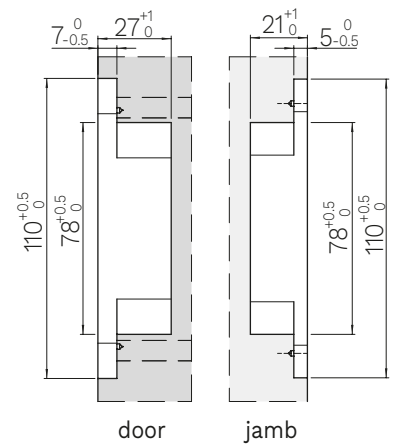

Installation of Hinge centered on the door leaf

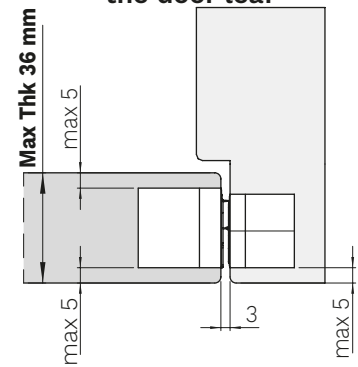

Installation of Hinge NOT centered on the door leaf

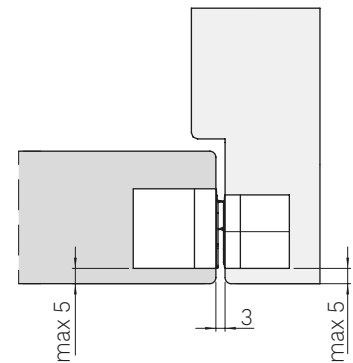

Fixing screws included



The hinge fixing is ensured by using the **fixing screws** indicated in the hinge assembly instructions.



Kombi HYBRID K1019 30 HYBRID

MADE IN ITALY

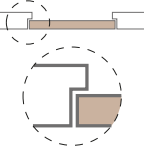
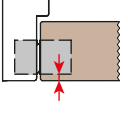
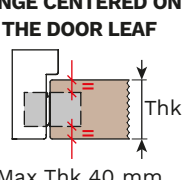
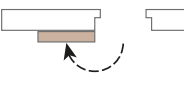
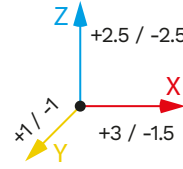
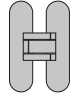
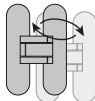
PATENTED

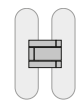
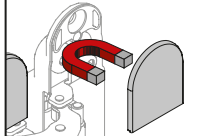
<p>HINGE MATERIAL</p> <p>Casing: Steel Adjustment body: Acetal plastic Connecting rods: Zamak</p>	<p>LOAD CAPACITY 40 kg (n.2 hinges)</p> 	<p>APPLICATION Flush to the wall door</p> 	<p>K DISTANCE</p>  <p>K-max 5 mm</p>
<p>HINGE CENTERED ON THE DOOR LEAF</p>  <p>Max Thk 40 mm</p>	<p>OPENING ANGLE 180°</p> 	<p>3D ADJUSTMENTS</p> 	
<p>FINISHING Full HD</p> 	<p>INTERCHANGEABLE WITH: K1060 30</p> 	<p>COVER MATERIAL Steel</p> 	<p>NUMBER OF ROTATION AXES 5</p> 
<p>MAGNETIC COVER</p> 	<p>SUITABLE FOR</p> <p>kiker</p>		

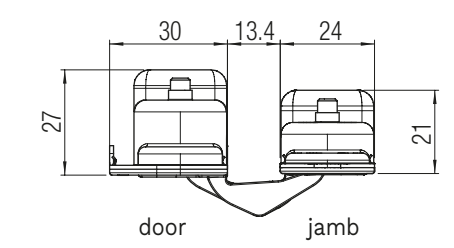
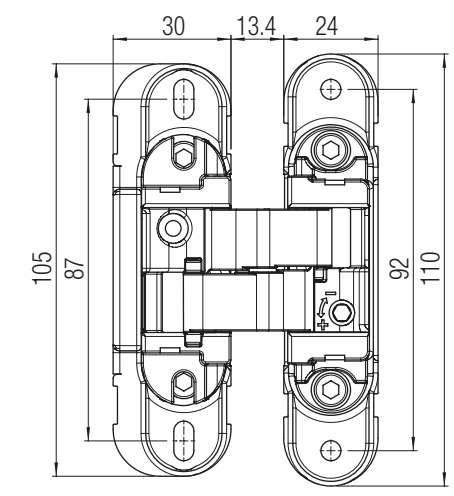
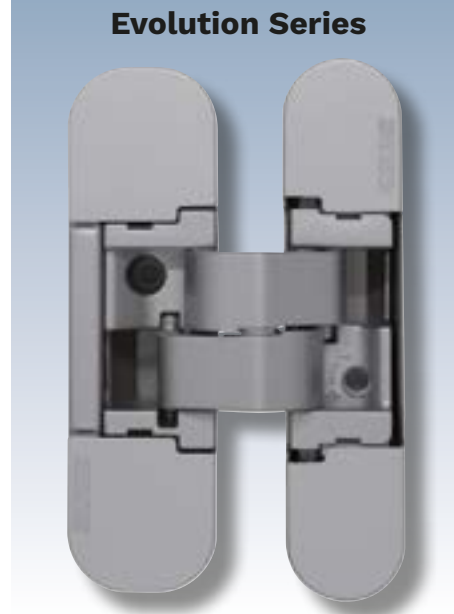

Product details:



Finishing		
Colour	Item number. standard	Item number. magnetic
Polished chrome	K 1019 30 CL	
Satin chrome	K 1019 30 CS	K 1019 30 CS CM
Satin nickel	K 1019 30 NS	K 1019 30 NS CM
Polished gold	K 1019 30 OL	
Satin gold	K 1019 30 OS	
Bronze	K 1019 30 BR	
White	K 1019 30 BI	K 1019 30 BI CM
Black	K 1019 30 NO	K 1019 30 NO CM

For other colours please ask Krona Koblenz for feasibility

Load capacity table (see the reading guide at page 12)

K1019 30 - 40 Kg - N.2 hinges												
Hinge spacing (mm)**	2000	40	40	40	40	40	40	40	40	40	38	37
	1950	40	40	40	40	40	40	40	40	39	38	36
	1900	40	40	40	40	40	40	40	40	38	37	35
	1850	40	40	40	40	40	40	40	40	39	37	34
	1800	40	40	40	40	40	40	39	38	36	35	33
	1750	40	40	40	40	40	40	38	37	35	34	32
	1700	40	40	40	40	40	39	37	36	34	33	31
	1650	40	40	40	40	40	38	36	35	33	32	31
	1600	40	40	40	40	39	37	35	33	32	31	30
	1550	40	40	40	39	37	36	34	32	31	30	29
	1500	40	40	40	38	36	34	33	31	30	29	28
1450	40	40	39	37	35	33	32	30	29	28	27	
1540	40											
	926	700	800	900	950	1000	1050	1100	1150	1200	1250	1300
Door leaf width (mm)**												

Test specifications:

- 2 hinges: Hinge spacing 1540 mm - Door leaf width 926 mm - Opening angle 0°-90°.

**With door dimensions and max opening angle different from the tested configuration and/or with the application of other devices such as, for example, door closers/bumpers/emergency handle/dropdown seal/etc. refer to the "Installation Examples". Please note that testing for these configurations is under customer's responsibility. We specify that the combinations are the result of interpolation and not of real tests, which remain under the customer's responsibility.

Standard application

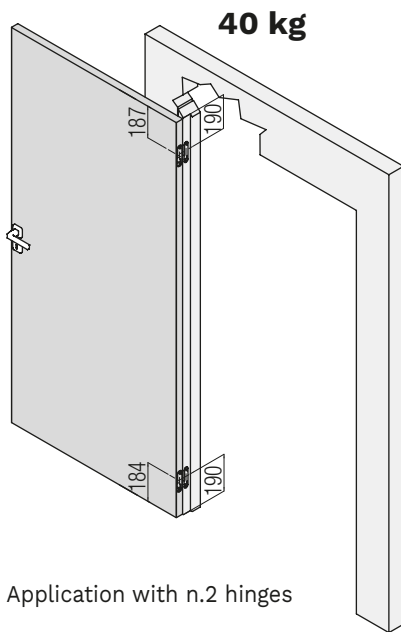

Application with n.2 hinges

Milling door/jamb

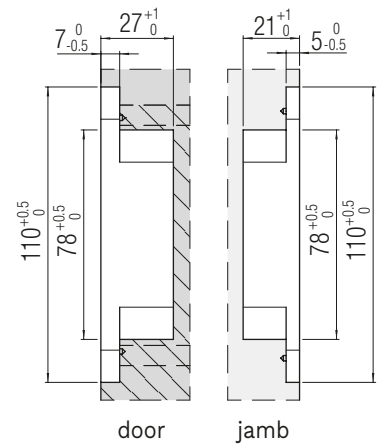

Installation of Hinge centered on the door leaf

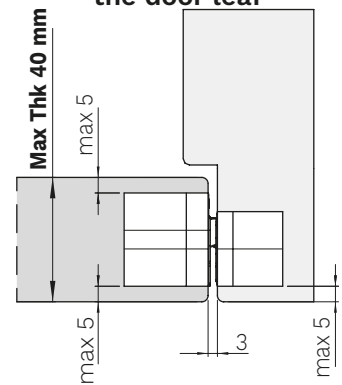

Installation of Hinge NOT centered on the door leaf

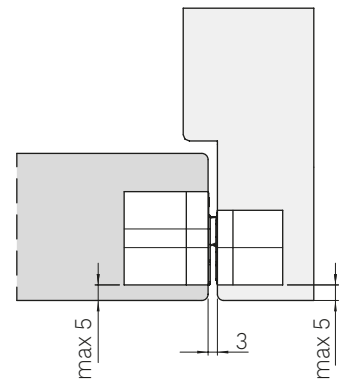

Fixing screws included



The hinge fixing is ensured by using the **fixing screws** indicated in the hinge assembly instructions.



Kombi HYBRID K1019 34 HYBRID

MADE IN ITALY

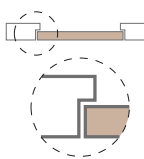
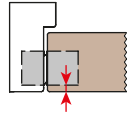
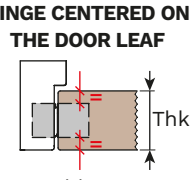
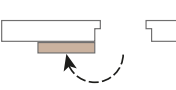
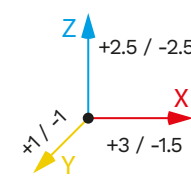
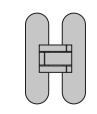
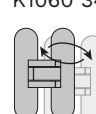
PATENTED

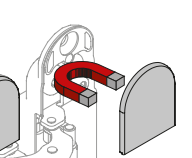
<p>HINGE MATERIAL</p> <p>Casing: Steel Adjustment body: Acetal plastic Connecting rods: Zamak</p>	<p>LOAD CAPACITY 40 kg (n.2 hinges)</p> 	<p>APPLICATION Flush to the wall door</p> 	<p>K DISTANCE</p>  <p>K-max 5 mm</p>
<p>HINGE CENTERED ON THE DOOR LEAF</p>  <p>Max Thk 44 mm</p>	<p>OPENING ANGLE 180°</p> 	<p>3D ADJUSTMENTS</p> 	
<p>FINISHING Full HD</p> 	<p>INTERCHANGEABLE WITH: K1060 34</p> 	<p>COVER MATERIAL Steel</p> 	<p>NUMBER OF ROTATION AXES 5</p> 
<p>MAGNETIC COVER</p> 	<p>SUITABLE FOR</p> <p>kiker</p>		

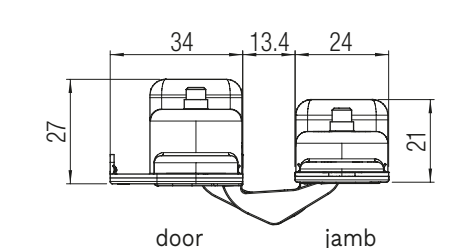
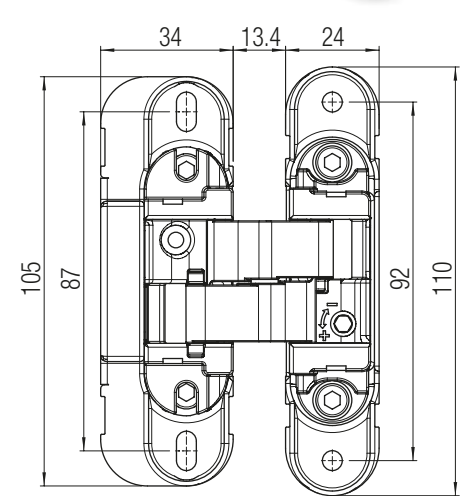
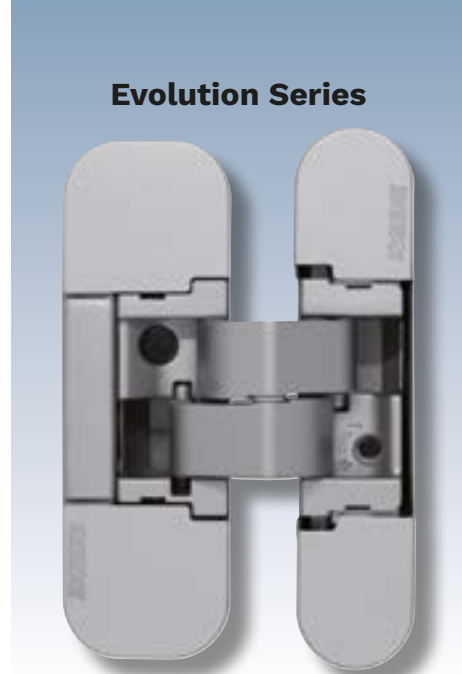

Product details:



Finishing		
Colour	Item number. standard	Item number. magnetic
Polished chrome	K 1019 34 CL	K 1019 34 CL CM
Satin chrome	K 1019 34 CS	K 1019 34 CS CM
Satin nickel	K 1019 34 NS	K 1019 34 NS CM
Polished gold	K 1019 34 OL	K 1019 34 OL CM
Satin gold	K 1019 34 OS	
Bronze	K 1019 34 BR	K 1019 34 BR CM
White	K 1019 34 BI	K 1019 34 BI CM
Black	K 1019 34 NO	K 1019 34 NO CM

For other colours please ask Krona Koblenz for feasibility

Load capacity table (see the reading guide at page 12)

K1019 34 - 40 Kg - N.2 hinges												
Hinge spacing (mm)**	2000	40	40	40	40	40	40	40	40	40	38	37
	1950	40	40	40	40	40	40	40	40	39	38	36
	1900	40	40	40	40	40	40	40	40	38	37	35
	1850	40	40	40	40	40	40	40	40	39	37	34
	1800	40	40	40	40	40	40	39	38	36	35	33
	1750	40	40	40	40	40	40	38	37	35	34	32
	1700	40	40	40	40	40	39	37	36	34	33	31
	1650	40	40	40	40	40	38	36	35	33	32	31
	1600	40	40	40	40	39	37	35	33	32	31	30
	1550	40	40	40	39	37	36	34	32	31	30	29
	1500	40	40	40	38	36	34	33	31	30	29	28
1450	40	40	39	37	35	33	32	30	29	28	27	
1540	40											
	926	700	800	900	950	1000	1050	1100	1150	1200	1250	1300
		Door leaf width (mm)**										

Test specifications:

- 2 hinges: Hinge spacing 1540 mm - Door leaf width 926 mm - Opening angle 0°-90°.

**With door dimensions and max opening angle different from the tested configuration and/or with the application of other devices such as, for example, door closers/bumpers/emergency handle/dropdown seal/etc. refer to the "Installation Examples". Please note that testing for these configurations is under customer's responsibility. We specify that the combinations are the result of interpolation and not of real tests, which remain under the customer's responsibility.

Standard application

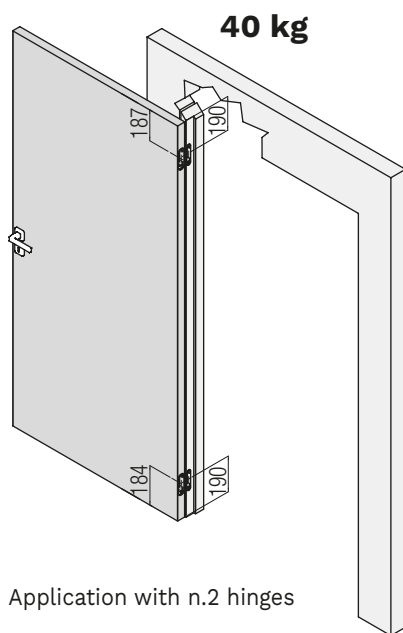

Application with n.2 hinges

Milling door/jamb

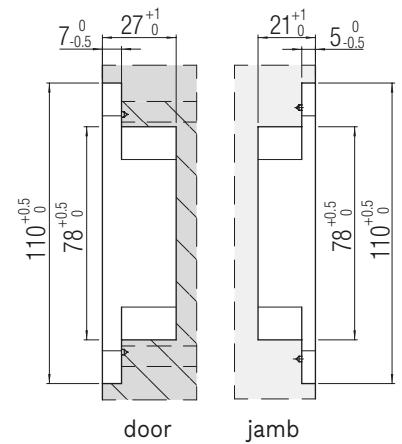

door jamb

Installation of Hinge centered on the door leaf

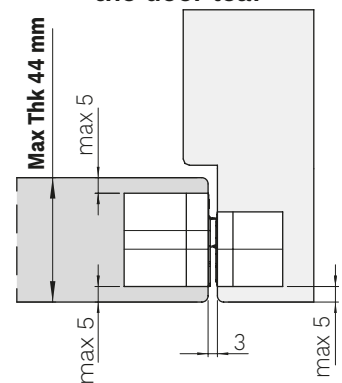

Installation of Hinge NOT centered on the door leaf

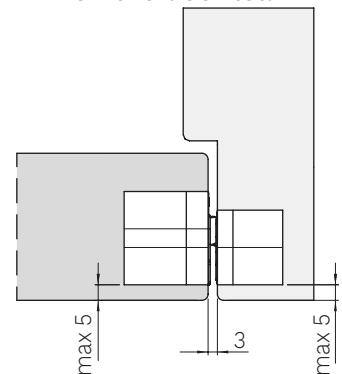



Fixing screws included

The hinge fixing is ensured by using the **fixing screws** indicated in the hinge assembly instructions.

Kombi **HYBRID** K1060 HYBRID

MADE IN ITALY

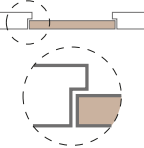
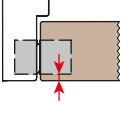
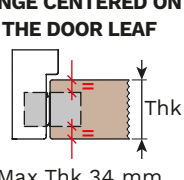
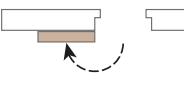
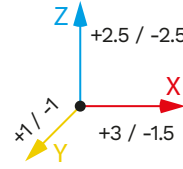
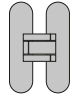
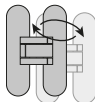
PATENTED

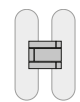
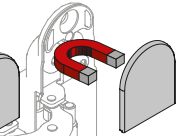
<p>HINGE MATERIAL</p> <p>Casing: Steel Adjustment body: Zamak Connecting rods: Zamak</p>	<p>LOAD CAPACITY 60 kg (n.2 hinges)</p> 	<p>APPLICATION Flush to the wall door</p> 	<p>K DISTANCE</p>  <p>K-max 5 mm</p>
<p>HINGE CENTERED ON THE DOOR LEAF</p>  <p>Max Thk 34 mm</p>	<p>OPENING ANGLE 180°</p> 	<p>3D ADJUSTMENTS</p>  <p>Z: +2.5 / -2.5 X: +3 / -1.5 Y: +1 / -1</p>	
<p>FINISHING Full HD</p> 	<p>INTERCHANGEABLE WITH: K1019</p> 	<p>COVER MATERIAL Steel</p> 	<p>NUMBER OF ROTATION AXES 5</p> 
<p>MAGNETIC COVER</p> 	<p>SUITABLE FOR</p> <h2>kiker</h2>		

Evolution Series

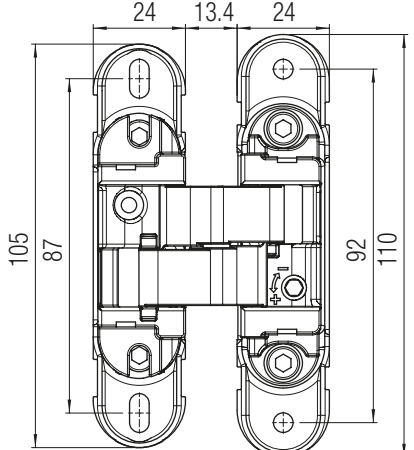
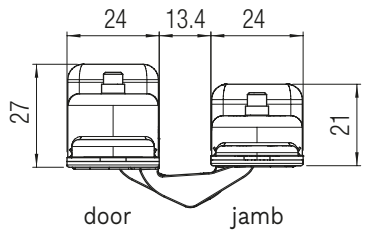
door jamb

Finishing		
Colour	Item number. standard	Item number. magnetic
Satin chrome	K 1060 CS	K 1060 CS CM
Satin nickel	K 1060 NS	K 1060 NS CM
White	K 1060 BI	K 1060 BI CM
Black	K 1060 NO	K 1060 NO CM

For other colours please ask Krona Koblenz for feasibility



Product details:



Load capacity table (see the reading guide at page 12)

K1060 - 60 Kg - N.2 hinges												
Hinge spacing (mm)**	2000	60	60	60	60	60	60	60	60	60	58	56
	1950	60	60	60	60	60	60	60	60	60	59	56
	1900	60	60	60	60	60	60	60	60	60	57	55
	1850	60	60	60	60	60	60	60	60	60	58	56
	1800	60	60	60	60	60	60	59	56	54	52	50
	1750	60	60	60	60	60	60	57	55	53	51	49
	1700	60	60	60	60	60	58	56	53	51	49	47
	1650	60	60	60	60	60	57	54	52	50	48	46
	1600	60	60	60	60	59	55	52	50	48	46	44
	1550	60	60	60	59	56	53	51	49	47	45	43
	1500	60	60	60	57	54	52	49	47	45	43	42
1450	60	60	58	55	52	50	48	45	44	42	40	
1540	60											
	926	700	800	900	950	1000	1050	1100	1150	1200	1250	1300
	Door leaf width (mm)**											

Test specifications:

- 2 hinges: Hinge spacing 1540 mm - Door leaf width 926 mm - Opening angle 0°-90°.

**With door dimensions and max opening angle different from the tested configuration and/or with the application of other devices such as, for example, door closers/bumpers/emergency handle/dropdown seal/etc. refer to the "Installation Examples". Please note that testing for these configurations is under customer's responsibility. We specify that the combinations are the result of interpolation and not of real tests, which remain under the customer's responsibility.

Standard application

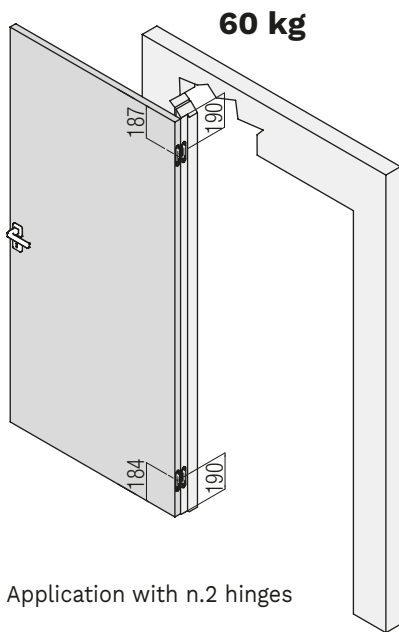

Application with n.2 hinges

Milling door/jamb

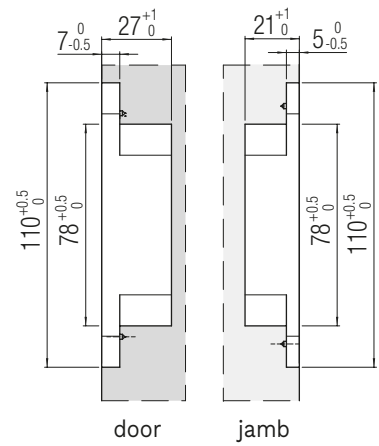

Installation of Hinge centered on the door leaf

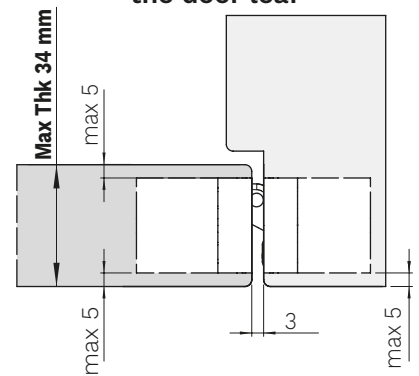

Installation of Hinge NOT centered on the door leaf

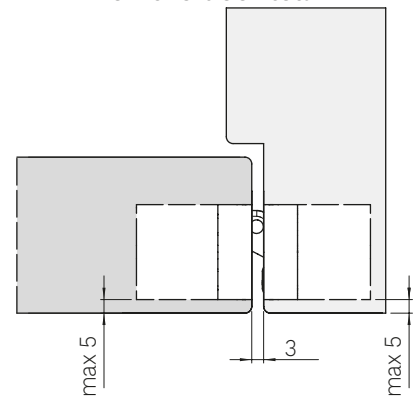



 **Fixing screws included**

The hinge fixing is ensured by using the **fixing screws** indicated in the hinge assembly instructions.

Kombi HYBRID K1060 26 HYBRID

MADE IN ITALY

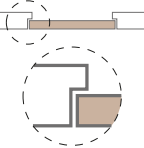
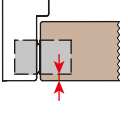
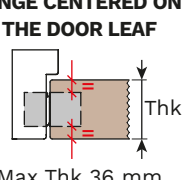
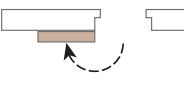
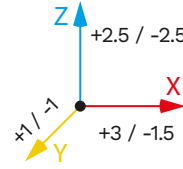
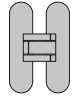
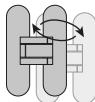
PATENTED

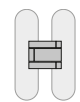
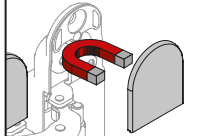
<p>HINGE MATERIAL</p> <p>Casing: Steel Adjustment body: Zamak Connecting rods: Zamak</p>	<p>LOAD CAPACITY 60 kg (n.2 hinges)</p> 	<p>APPLICATION Flush to the wall door</p> 	<p>K DISTANCE</p>  <p>K-max 5 mm</p>
<p>HINGE CENTERED ON THE DOOR LEAF</p>  <p>Max Thk 36 mm</p>	<p>OPENING ANGLE 180°</p> 	<p>3D ADJUSTMENTS</p> 	
<p>FINISHING Full HD</p> 	<p>INTERCHANGEABLE WITH: K1019 26</p> 	<p>COVER MATERIAL Steel</p> 	<p>NUMBER OF ROTATION AXES 5</p> 
<p>MAGNETIC COVER</p> 	<p>SUITABLE FOR</p> <p>kiker</p>		

Evolution Series

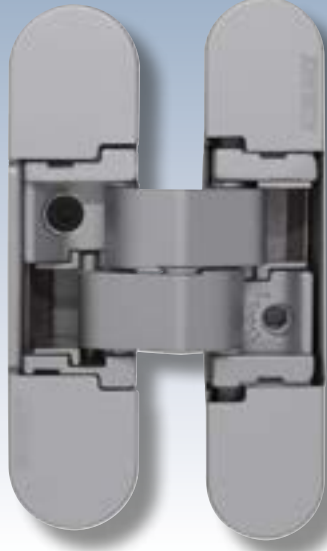
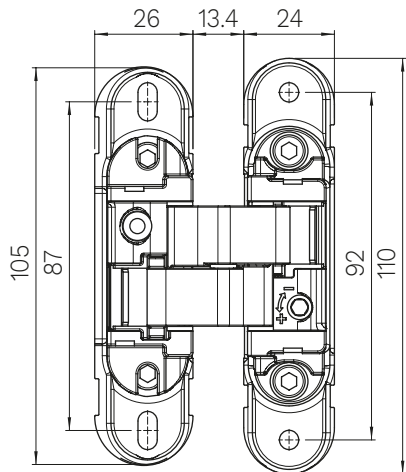
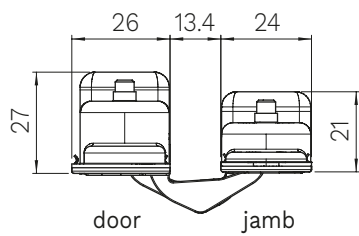
door jamb

Finishing		
Colour	Item number. standard	Item number. magnetic
Satin chrome	K 1060 26 CS	K 1060 26 CS CM
Satin nickel	K 1060 26 NS	
White	K 1060 26 BI	
Black	K 1060 26 NO	

For other colours please ask Krona Koblenz for feasibility



Load capacity table (see the reading guide at page 12)

K1060 26 - 60 Kg - N.2 hinges												
Hinge spacing (mm)**	2000	60	60	60	60	60	60	60	60	60	58	56
	1950	60	60	60	60	60	60	60	60	60	59	56
	1900	60	60	60	60	60	60	60	60	60	57	55
	1850	60	60	60	60	60	60	60	60	60	58	56
	1800	60	60	60	60	60	60	60	59	56	54	52
	1750	60	60	60	60	60	60	60	57	55	53	51
	1700	60	60	60	60	60	60	58	56	53	51	49
	1650	60	60	60	60	60	60	57	54	52	50	48
	1600	60	60	60	60	60	59	55	52	50	48	46
	1550	60	60	60	60	59	56	53	51	49	47	45
	1500	60	60	60	57	54	52	49	47	45	43	42
1450	60	60	58	55	52	50	48	45	44	42	40	
1540	60											
	926	700	800	900	950	1000	1050	1100	1150	1200	1250	1300
	Door leaf width (mm)**											

Test specifications:

- 2 hinges: Hinge spacing 1540 mm - Door leaf width 926 mm - Opening angle 0°-90°.

**With door dimensions and max opening angle different from the tested configuration and/or with the application of other devices such as, for example, door closers/bumpers/emergency handle/dropdown seal/etc. refer to the "Installation Examples". Please note that testing for these configurations is under customer's responsibility. We specify that the combinations are the result of interpolation and not of real tests, which remain under the customer's responsibility.

Standard application

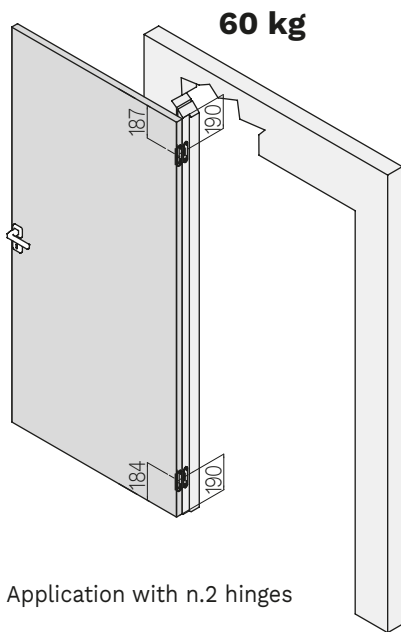

Application with n.2 hinges

Milling door/jamb

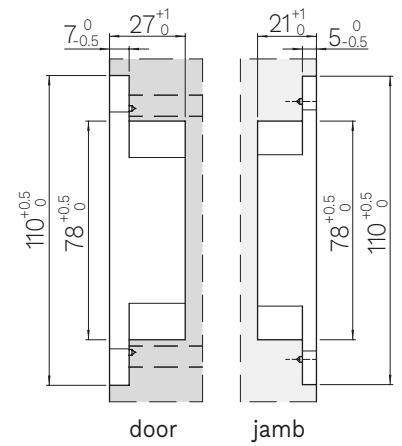

Installation of Hinge centered on the door leaf

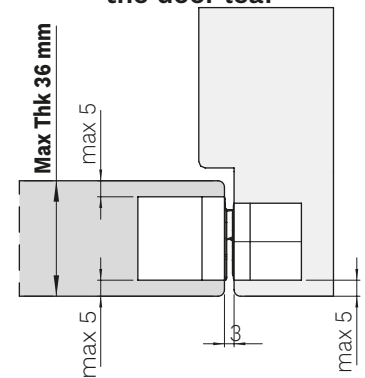

Installation of Hinge NOT centered on the door leaf

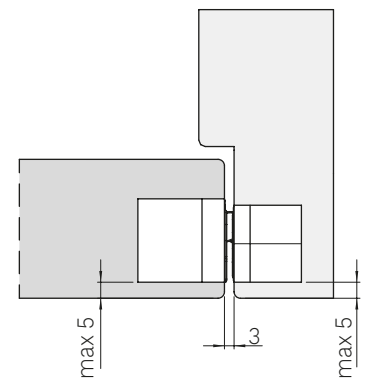





Fixing screws included

The hinge fixing is ensured by using the **fixing screws** indicated in the hinge assembly instructions.

Kombi HYBRID K1060 30 HYBRID

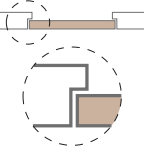
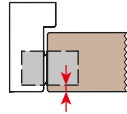
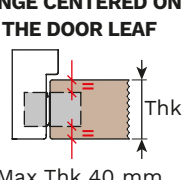
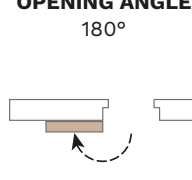
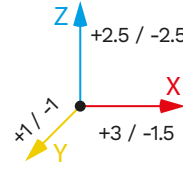
MADE IN ITALY

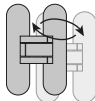
PATENTED

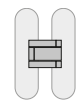
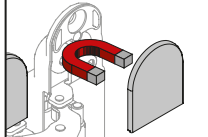
<p>HINGE MATERIAL</p> <p>Casing: Steel Adjustment body: Zamak Connecting rods: Zamak</p>	<p>LOAD CAPACITY 60 kg (n.2 hinges)</p> 	<p>APPLICATION Flush to the wall door</p> 	<p>K DISTANCE</p>  <p>K-max 5 mm</p>
<p>HINGE CENTERED ON THE DOOR LEAF</p>  <p>Max Thk 40 mm</p>	<p>OPENING ANGLE 180°</p> 	<p>3D ADJUSTMENTS</p>  <p>Z: +2.5 / -2.5 X: +3 / -1.5 Y: +1 / -1</p>	
<p>FINISHING Full HD</p> 	<p>INTERCHANGEABLE WITH: K1019 30</p> 	<p>COVER MATERIAL Steel</p> 	<p>NUMBER OF ROTATION AXES 5</p> 
<p>MAGNETIC COVER</p> 	<p>SUITABLE FOR</p> <p>kiker</p>		

Evolution Series

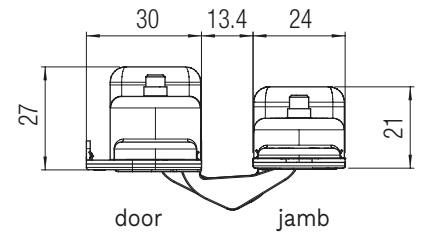
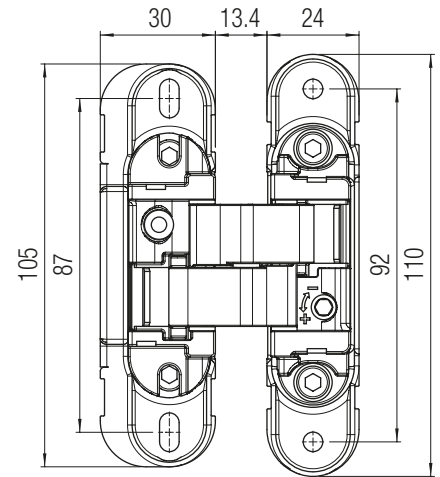
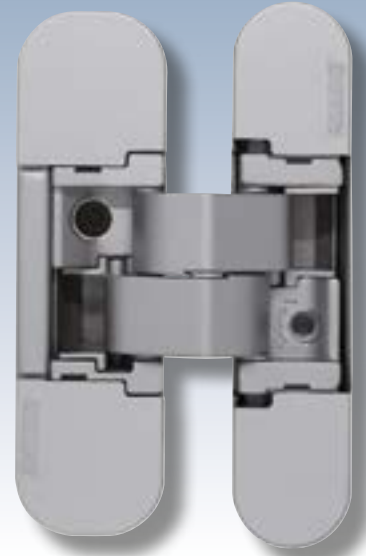

Product details:



Finishing		
Colour	Item number. standard	Item number. magnetic
Satin chrome	K 1060 30 CS	K 1060 30 CS CM
Satin nickel	K 1060 30 NS	
White	K 1060 30 BI	
Black	K 1060 30 NO	

For other colours please ask Krona Koblenz for feasibility



Load capacity table (see the reading guide at page 12)

Hinge spacing (mm)**	K1060 30 - 60 Kg - N.2 hinges											
	60	70	80	90	100	110	120	130	140	150	160	
2000	60	60	60	60	60	60	60	60	60	58	56	
1950	60	60	60	60	60	60	60	60	60	59	56	
1900	60	60	60	60	60	60	60	60	60	57	55	
1850	60	60	60	60	60	60	60	60	60	58	56	
1800	60	60	60	60	60	60	59	56	54	52	50	
1750	60	60	60	60	60	60	57	55	53	51	49	
1700	60	60	60	60	60	58	56	53	51	49	47	
1650	60	60	60	60	60	57	54	52	50	48	46	
1600	60	60	60	60	58	55	52	50	48	46	44	
1550	60	60	60	59	56	53	51	49	47	45	43	
1500	60	60	60	57	54	52	49	47	45	43	42	
1450	60	60	58	55	52	50	48	45	44	42	40	
1540	60											
	926	700	800	900	950	1000	1050	1100	1150	1200	1250	1300

Door leaf width (mm)**

Test specifications:

- 2 hinges: Hinge spacing 1540 mm - Door leaf width 926 mm - Opening angle 0°-90°.

**With door dimensions and max opening angle different from the tested configuration and/or with the application of other devices such as, for example, door closers/bumpers/emergency handle/dropdown seal/etc. refer to the "Installation Examples". Please note that testing for these configurations is under customer's responsibility. We specify that the combinations are the result of interpolation and not of real tests, which remain under the customer's responsibility.

Standard application

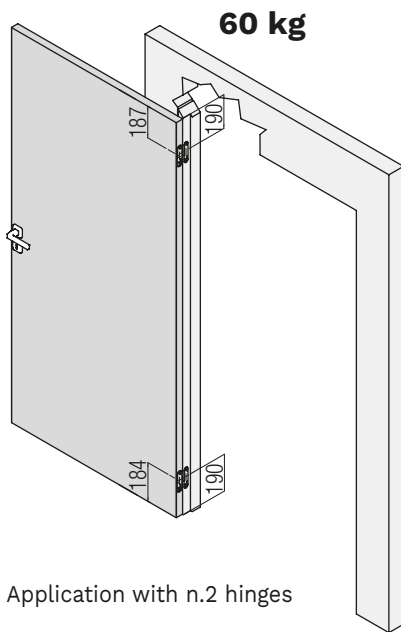

Application with n.2 hinges

Milling door/jamb

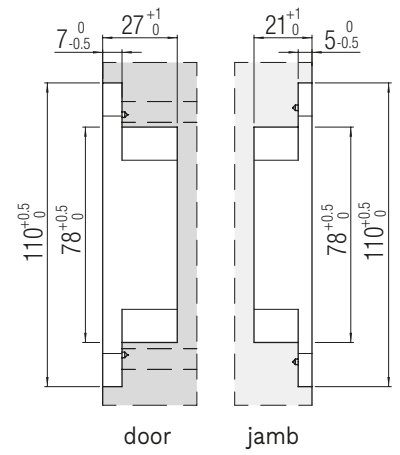

Installation of Hinge centered on the door leaf

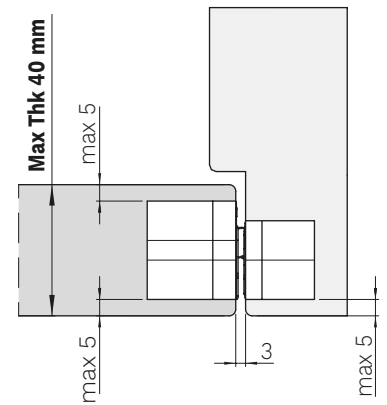

Installation of Hinge NOT centered on the door leaf

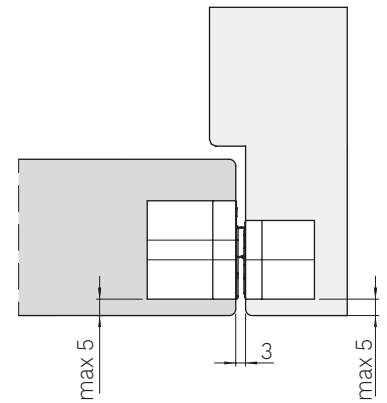







Fixing screws included

The hinge fixing is ensured by using the **fixing screws** indicated in the hinge assembly instructions.

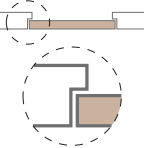
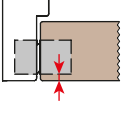
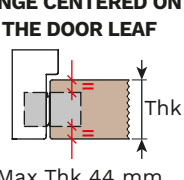
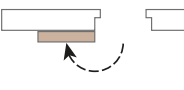
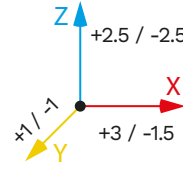
Kombi **HYBRID** K1060 34 HYBRID

MADE IN ITALY

PATENTED

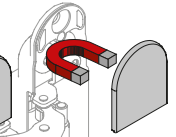
<p>HINGE MATERIAL</p> <p>Casing: Steel Adjustment body: Zamak Connecting rods: Zamak</p>	<p>LOAD CAPACITY 60 kg (n.2 hinges)</p> 	<p>APPLICATION Flush to the wall door</p> 	<p>K DISTANCE</p>  <p>K-max 5 mm</p>
<p>HINGE CENTERED ON THE DOOR LEAF</p>  <p>Max Thk 44 mm</p>	<p>OPENING ANGLE 180°</p> 	<p>3D ADJUSTMENTS</p>  <p>Z: +2.5 / -2.5 X: +3 / -1.5 Y: +1 / -1</p>	<p>NUMBER OF ROTATION AXES 5</p> 
<p>FINISHING Full HD</p> 	<p>INTERCHANGEABLE WITH: K1019 34</p> 	<p>COVER MATERIAL Steel</p> 	<p>NUMBER OF ROTATION AXES 5</p> 
<p>MAGNETIC COVER</p> 	<p>SUITABLE FOR</p> <p>kiker</p>		

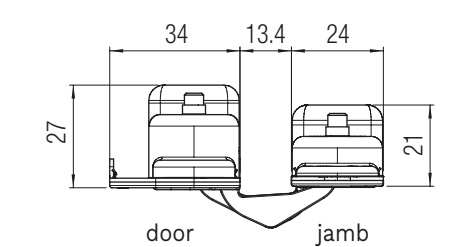
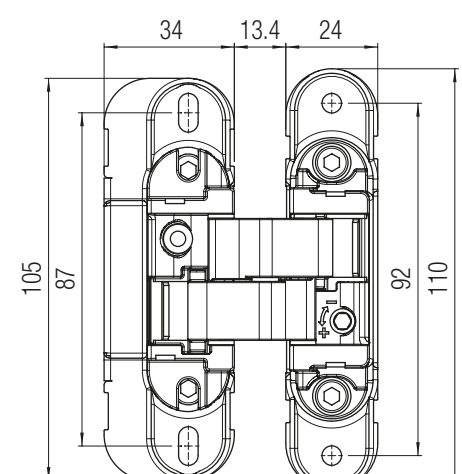
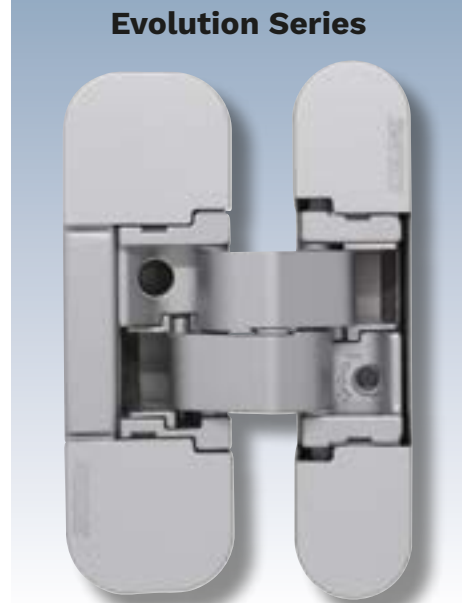

Product details:



Finishing		
Colour	Item number. standard	Item number. magnetic
Satin chrome	K 1060 34 CS	K 1060 34 CS CM
Satin nickel	K 1060 34 NS	
White	K 1060 34 BI	
Black	K 1060 34 NO	

For other colours please ask Krona Koblenz for feasibility

Load capacity table (see the reading guide at page 12)

K1060 34 - 60 Kg - N.2 hinges												
Hinge spacing (mm)**	2000	60	60	60	60	60	60	60	60	60	58	56
	1950	60	60	60	60	60	60	60	60	60	59	56
	1900	60	60	60	60	60	60	60	60	60	57	55
	1850	60	60	60	60	60	60	60	60	60	58	56
	1800	60	60	60	60	60	60	59	56	54	52	50
	1750	60	60	60	60	60	60	57	55	53	51	49
	1700	60	60	60	60	60	58	56	53	51	49	47
	1650	60	60	60	60	60	57	54	52	50	48	46
	1600	60	60	60	60	58	55	52	50	48	46	44
	1550	60	60	60	59	56	53	51	49	47	45	43
	1500	60	60	60	57	54	52	49	47	45	43	42
1450	60	60	58	55	52	50	48	45	44	42	40	
1540	60											
	926	700	800	900	950	1000	1050	1100	1150	1200	1250	1300
Door leaf width (mm)**												

Test specifications:

- 2 hinges: Hinge spacing 1540 mm - Door leaf width 926 mm - Opening angle 0°-90°.

**With door dimensions and max opening angle different from the tested configuration and/or with the application of other devices such as, for example, door closers/bumpers/emergency handle/dropdown seal/etc. refer to the "Installation Examples". Please note that testing for these configurations is under customer's responsibility. We specify that the combinations are the result of interpolation and not of real tests, which remain under the customer's responsibility.

Standard application

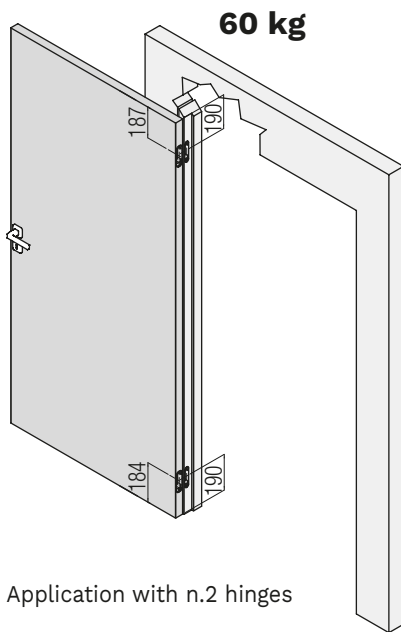

Application with n.2 hinges

Milling door/jamb

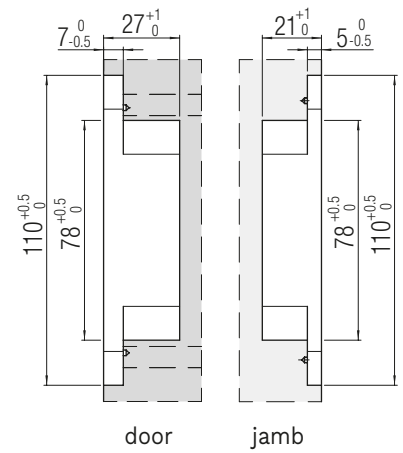

Installation of Hinge centered on the door leaf

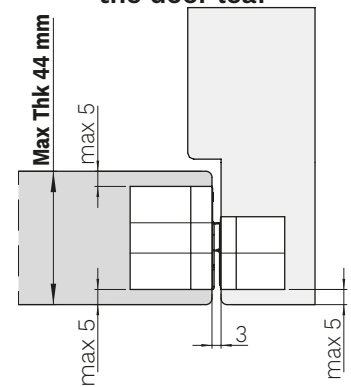

Installation of Hinge NOT centered on the door leaf

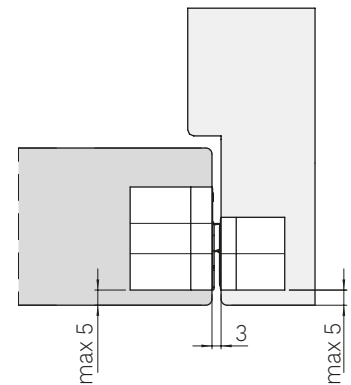







Fixing screws included

The hinge fixing is ensured by using the **fixing screws** indicated in the hinge assembly instructions.

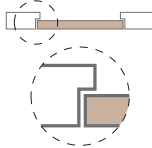
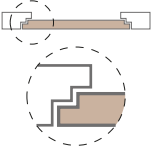
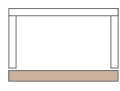
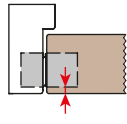
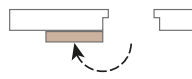
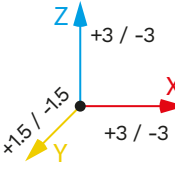
KUBICA K2460 HYBRID

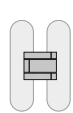
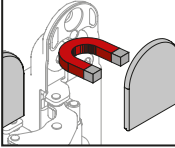
PATENTED

MADE IN ITALY

HINGE MATERIAL Casing: Steel Adjustment body: Zamak Connecting rods: Zamak	LOAD CAPACITY 60 kg (n.2 hinges) 	APPLICATION Flush to the wall door 	APPLICATION Door leaf with internal rebate 									
APPLICATION Furniture 	K DISTANCE  K-max 4 mm	OPENING ANGLE 180° 	3D ADJUSTMENTS 									
FINISHING Full HD 	COVER MATERIAL Steel 	NUMBER OF ROTATION AXES 5 	MAGNETIC COVER 									
SUITABLE FOR 	Rif. report reference N° R27182-20130522 	EN 1634-1  30 min.	EN 1670 Spray salt tested 240 hours									
 Product Quality N° 20-000798-PR01 - 11/05/2020 Multi-axis, concealed hinges EAD 020001-01-0405 Reg.-N°: 9000283	<table border="1"> <tr> <td>CE</td> <td>Krona Koblenz SpA Via Romero, 1 47853 Coriano</td> <td>21</td> </tr> <tr> <td>0757</td> <td>ETA-17/0575 DpPDoP-Nr. 00771A/CPR2021-06-28</td> <td>2 7 3 1 1 4* 0 10</td> </tr> <tr> <td colspan="2">0757-CPR-22/EAD-9000283-2-3 HINGES DO NOT CONTAIN HARMFUL SUBSTANCES</td> <td>KUBICA HYBRID K2460</td> </tr> </table> <p>https://www.kronakoblenz.com/certificazioni/pdf/ce-certificate-k6200-k5080-k2460-koblenz.pdf</p>			CE	Krona Koblenz SpA Via Romero, 1 47853 Coriano	21	0757	ETA-17/0575 DpPDoP-Nr. 00771A/CPR2021-06-28	2 7 3 1 1 4* 0 10	0757-CPR-22/EAD-9000283-2-3 HINGES DO NOT CONTAIN HARMFUL SUBSTANCES		KUBICA HYBRID K2460
CE	Krona Koblenz SpA Via Romero, 1 47853 Coriano	21										
0757	ETA-17/0575 DpPDoP-Nr. 00771A/CPR2021-06-28	2 7 3 1 1 4* 0 10										
0757-CPR-22/EAD-9000283-2-3 HINGES DO NOT CONTAIN HARMFUL SUBSTANCES		KUBICA HYBRID K2460										

Evolution Series

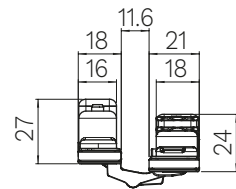
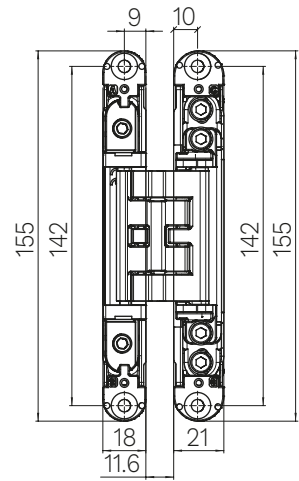

door jamb



Product details:



Finishing

Colour	Item number. standard	Item number. magnetic
Satin chrome	K 2460 CS	K 2460 CS CM
Satin nickel	K 2460 NS	K 2460 NS CM
Polished gold	K 2460 OL	K 2460 OL CM
Satin gold		K 2460 OS CM
Bronze	K 2460 BR	K 2460 BR CM
White	K 2460 BI	K 2460 BI CM
Black	K 2460 NO	K 2460 NO CM

For other colours please ask Krona Koblenz for feasibility



Load capacity table (see the reading guide at page 12)

K2460 - 60 Kg - N.2 hinges												
Hinge spacing (mm)**	2000	60	60	60	60	60	60	60	60	60	58	56
	1950	60	60	60	60	60	60	60	60	60	59	56
	1900	60	60	60	60	60	60	60	60	60	57	55
	1850	60	60	60	60	60	60	60	60	60	58	56
	1800	60	60	60	60	60	60	60	59	56	54	52
	1750	60	60	60	60	60	60	60	57	55	53	51
	1700	60	60	60	60	60	60	58	56	53	51	49
	1650	60	60	60	60	60	60	57	54	52	50	48
	1600	60	60	60	60	60	58	55	52	50	48	46
	1550	60	60	60	60	59	56	53	51	49	47	45
	1500	60	60	60	57	54	52	49	47	45	43	42
1450	60	60	58	55	52	50	48	45	44	42	40	
1540	60											
	926	700	800	900	950	1000	1050	1100	1150	1200	1250	1300
	Door leaf width (mm)**											

Test specifications:

- 2 hinges: Hinge spacing 1540 mm - Door leaf width 926 mm - Opening angle 0°-90°.

**With door dimensions and max opening angle different from the tested configuration and/or with the application of other devices such as, for example, door closers/bumpers/emergency handle/dropdown seal/etc. refer to the "Installation Examples". Please note that testing for these configurations is under customer's responsibility. We specify that the combinations are the result of interpolation and not of real tests, which remain under the customer's responsibility.

Standard application

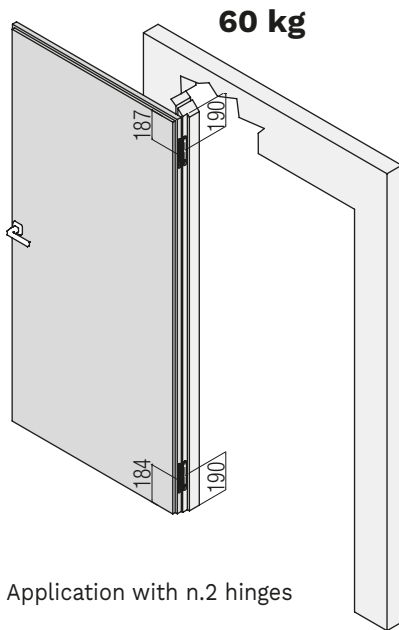

Application with n.2 hinges

Milling door/jamb

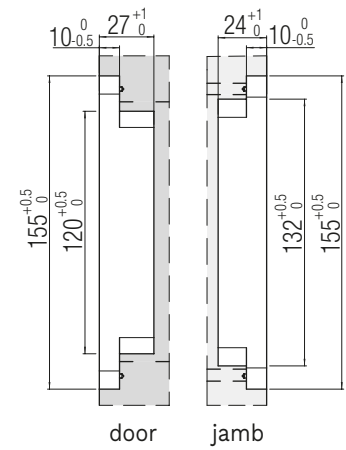

Installation of Hinge NOT centered on the door leaf

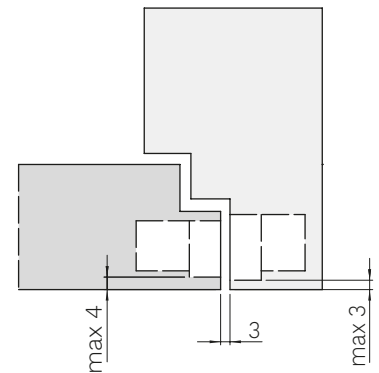





Fixing screws included
The hinge fixing is ensured by using the **fixing screws and adapters** indicated in the hinge assembly instructions.

KUBICA K6360 38 HYBRID

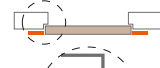
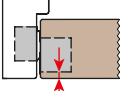
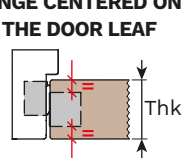
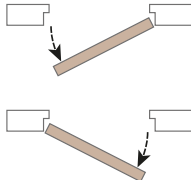
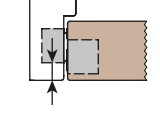
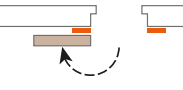
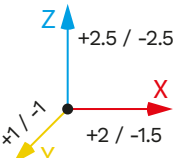
PATENTED

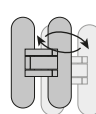
MADE IN ITALY

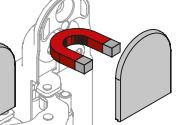
<p>HINGE MATERIAL</p> <p>Casing: Steel Adjustment body: Zamak Connecting rods: Zamak</p>	<p>LOAD CAPACITY 60 kg (n.2 hinges)</p> 	<p>APPLICATION Door flush to the trim (offset hinge)</p>  <p>max 12 mm</p>	<p>K DISTANCE</p>  <p>K-max 4 mm</p>
<p>HINGE CENTERED ON THE DOOR LEAF</p>  <p>Max Thk 38 mm</p>		 <p>max 12 mm</p>	<p>OPENING ANGLE 180°</p> 
<p>3D ADJUSTMENTS</p>  <p>Z: +2.5 / -2.5 X: +2 / -1.5 Y: +1 / -1</p>	<p>FINISHING Full HD</p> 	<p>INTERCHANGEABLE WITH: K6380 38</p> 	<p>COVER MATERIAL Steel</p> 
<p>NUMBER OF ROTATION AXES 5</p> 	<p>MAGNETIC COVER</p> 	<p>Test report</p> <p>ift ROSENHEIM</p> <p>UNI EN1191:2012 Windows and doors Resistance to opening and closing</p> <p>Internal door with hinges mod. K6360 38/45 Total door weight: 60kg</p>	

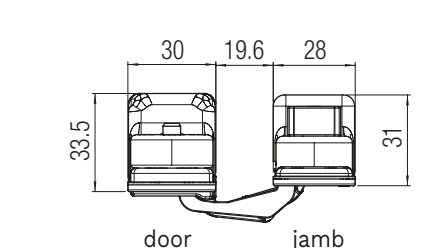
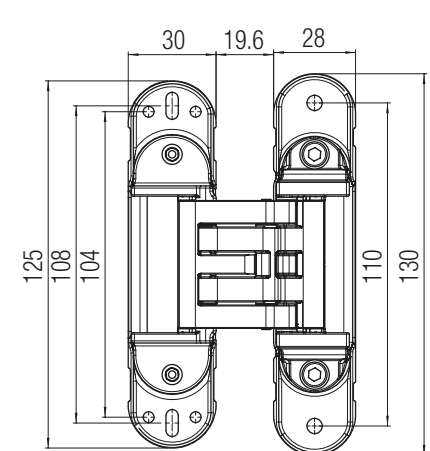

Finishing

Colour	Item number. standard	Item number. magnetic
Polished chrome	K 6360 38 CL	K 6360 38 CL CM
Satin chrome	K 6360 38 CS	K 6360 38 CS CM
Satin nickel	K 6360 38 NS	K 6360 38 NS CM
Polished gold	K 6360 38 OL	K 6360 38 OL CM
Satin gold	K 6360 38 OS	K 6360 38 OS CM
Bronze	K 6360 38 BR	K 6360 38 BR CM
Brushed bronze	K 6360 38 BS	
Polished brass	K 6360 38 OTL	K 6360 38 OTL CM
White	K 6360 38 BI	K 6360 38 BI CM
Black	K 6360 38 NR	K 6360 38 NR CM

For other colours please ask Krona Koblenz for feasibility

Load capacity table (see the reading guide at page 12)

K6360 38 - 60 Kg - N.2 hinges												
Hinge spacing (mm)**	2000	60	60	60	60	60	60	60	60	60	58	56
	1950	60	60	60	60	60	60	60	60	60	59	56
	1900	60	60	60	60	60	60	60	60	60	57	55
	1850	60	60	60	60	60	60	60	60	60	58	56
	1800	60	60	60	60	60	60	60	59	56	54	52
	1750	60	60	60	60	60	60	60	57	55	53	51
	1700	60	60	60	60	60	60	58	56	53	51	49
	1650	60	60	60	60	60	60	57	54	52	50	48
	1600	60	60	60	60	60	58	55	52	50	48	46
	1550	60	60	60	60	59	56	53	51	49	47	45
	1500	60	60	60	57	54	52	49	47	45	43	42
1450	60	60	58	55	52	50	48	45	44	42	40	
1540	60											
	926	700	800	900	950	1000	1050	1100	1150	1200	1250	1300
		Door leaf width (mm)**										

Test specifications:

- 2 hinges: Hinge spacing 1540 mm - Door leaf width 926 mm - Opening angle 0°-90°.

**With door dimensions and max opening angle different from the tested configuration and/or with the application of other devices such as, for example, door closers/bumpers/emergency handle/dropdown seal/etc. refer to the "Installation Examples". Please note that testing for these configurations is under customer's responsibility. We specify that the combinations are the result of interpolation and not of real tests, which remain under the customer's responsibility.

Standard application

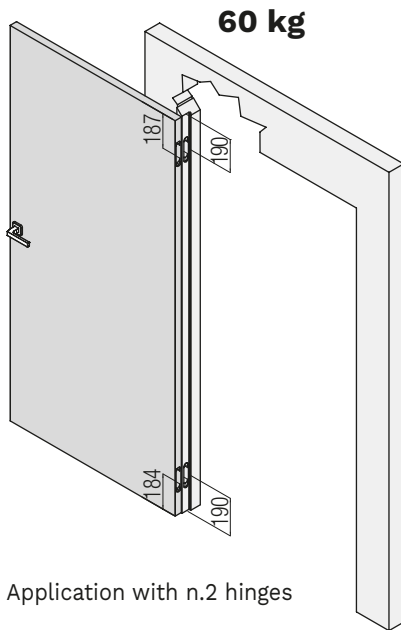

Application with n.2 hinges

Milling door/jamb

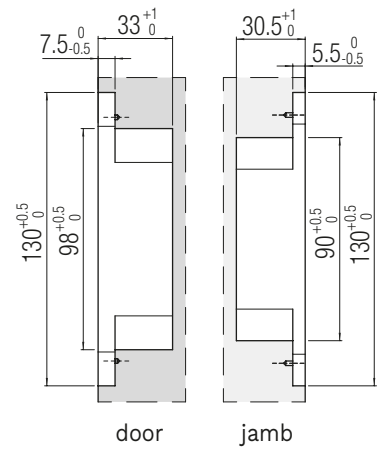

Installation of Hinge centered on the door leaf

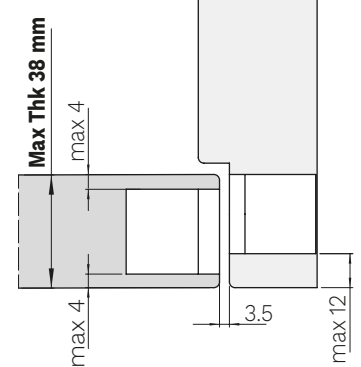

Installation of Hinge NOT centered on the door leaf

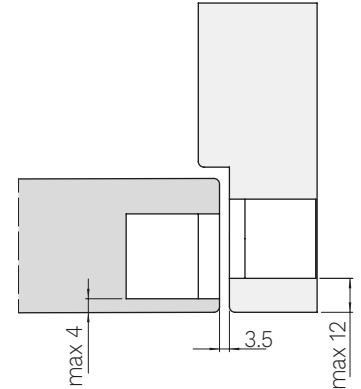



Fixing screws included

The hinge fixing is ensured by using the **fixing screws** indicated in the hinge assembly instructions.

KUBICA K6360 45 HYBRID

PATENTED

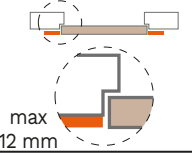
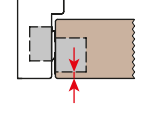
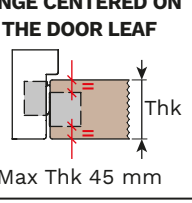
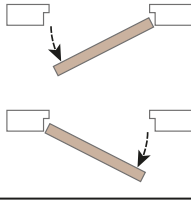
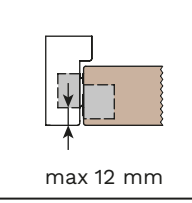
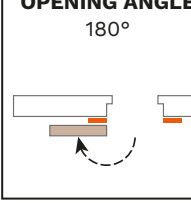
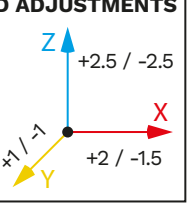
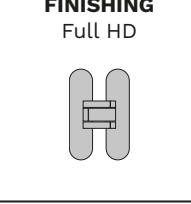
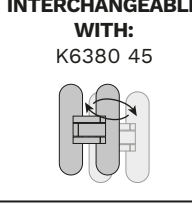
MADE IN ITALY

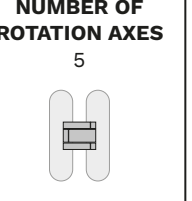
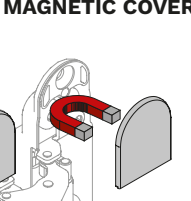
<p>HINGE MATERIAL</p> <p>Casing: Steel Adjustment body: Zamak Connecting rods: Zamak</p>	<p>LOAD CAPACITY 60 kg (n.2 hinges)</p> 	<p>APPLICATION Door flush to the trim (offset hinge)</p> 	<p>K DISTANCE</p>  <p>K-max 4 mm</p>
<p>HINGE CENTERED ON THE DOOR LEAF</p>  <p>Max Thk 45 mm</p>		 <p>max 12 mm</p>	<p>OPENING ANGLE 180°</p> 
<p>3D ADJUSTMENTS</p>  <p>Z: +2.5 / -2.5 X: +2 / -1.5 Y: +1 / -1</p>	<p>FINISHING Full HD</p> 	<p>INTERCHANGEABLE WITH: K6380 45</p> 	<p>COVER MATERIAL Steel</p> 
<p>NUMBER OF ROTATION AXES 5</p> 	<p>MAGNETIC COVER</p> 	<p>Test report</p> <p>ift ROSENHEIM</p> <p>UNI EN1191:2012 Windows and doors Resistance to opening and closing</p> <p>Internal door with hinges mod. K6360 38/45 Total door weight: 60kg</p>	

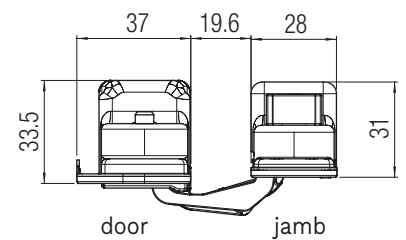
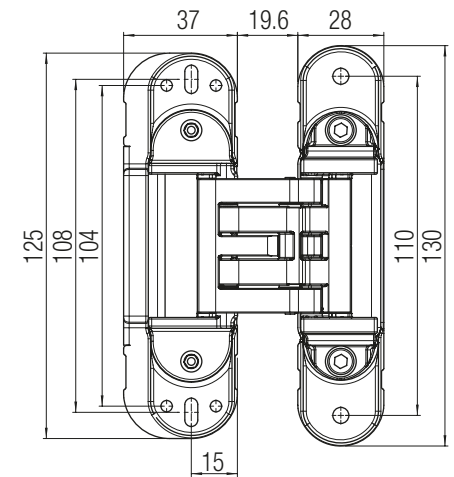

Finishing		
Colour	Item number. standard	Item number. magnetic
Polished chrome		K 6360 45 CL CM
Satin chrome	K 6360 45 CS	K 6360 45 CS CM
Satin nickel	K 6360 45 NS	K 6360 45 NS CM
Polished gold	K 6360 45 OL	K 6360 45 OL CM
Satin gold	K 6360 45 OS	K 6360 45 OS CM
Bronze	K 6360 45 BR	K 6360 45 BR CM
Polished brass	K 6360 45 OTL	K 6360 45 OTL CM
White	K 6360 45 BI	K 6360 45 BI CM
Black	K 6360 45 NR	K 6360 45 NR CM

For other colours please ask Krona Koblenz for feasibility



Product details:



Load capacity table (see the reading guide at page 12)

K6360 45 - 60 Kg - N.2 hinges												
Hinge spacing (mm)**	2000	60	60	60	60	60	60	60	60	60	58	56
	1950	60	60	60	60	60	60	60	60	60	59	56
	1900	60	60	60	60	60	60	60	60	60	57	55
	1850	60	60	60	60	60	60	60	60	60	58	56
	1800	60	60	60	60	60	60	60	59	56	54	52
	1750	60	60	60	60	60	60	60	57	55	53	51
	1700	60	60	60	60	60	60	58	56	53	51	49
	1650	60	60	60	60	60	60	57	54	52	50	48
	1600	60	60	60	60	60	58	55	52	50	48	46
	1550	60	60	60	60	59	56	53	51	49	47	45
	1500	60	60	60	57	54	52	49	47	45	43	42
	1450	60	60	58	55	52	50	48	45	44	42	40
1540	60											
	926	700	800	900	950	1000	1050	1100	1150	1200	1250	1300
		Door leaf width (mm)**										

Test specifications:

- 2 hinges: Hinge spacing 1540 mm - Door leaf width 926 mm - Opening angle 0°-90°.

**With door dimensions and max opening angle different from the tested configuration and/or with the application of other devices such as, for example, door closers/bumpers/emergency handle/dropdown seal/etc. refer to the "Installation Examples". Please note that testing for these configurations is under customer's responsibility. We specify that the combinations are the result of interpolation and not of real tests, which remain under the customer's responsibility.

Standard application

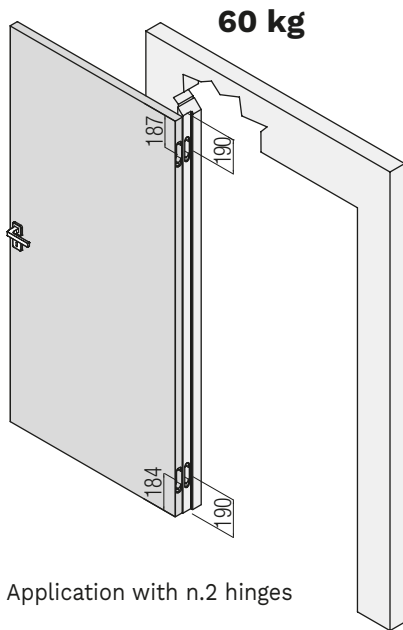

Application with n.2 hinges

Milling door/jamb

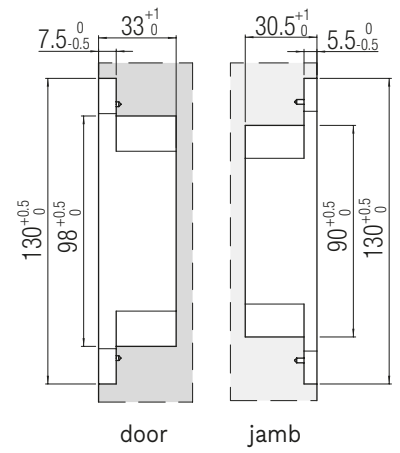

Installation of Hinge centered on the door leaf

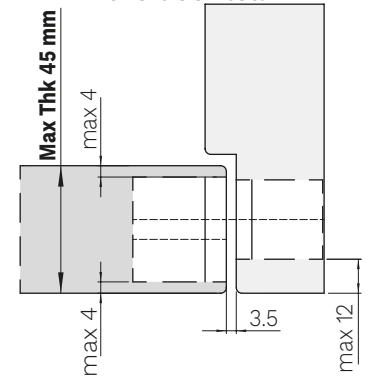

Installation of Hinge NOT centered on the door leaf

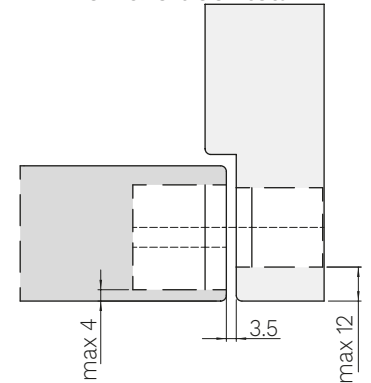



 **Fixing screws included**

The hinge fixing is ensured by using the **fixing screws** indicated in the hinge assembly instructions.

KUBICA K2760 HYBRID

PATENTED

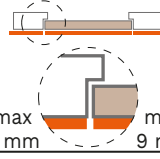
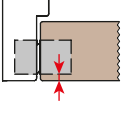
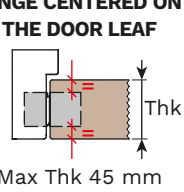
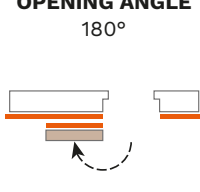
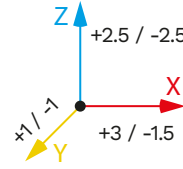
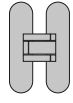
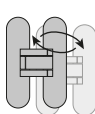
MADE IN ITALY

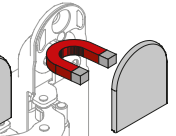
<p>HINGE MATERIAL</p> <p>Casing: Steel Adjustment body: Zamak Connecting rods: Zamak</p>	<p>LOAD CAPACITY 60 kg (n.2 hinges)</p> 	<p>APPLICATION Cladding</p> 	<p>K DISTANCE</p>  <p>K-max 9 mm</p>
<p>HINGE CENTERED ON THE DOOR LEAF</p>  <p>Max Thk 45 mm</p>	<p>OPENING ANGLE 180°</p> 	<p>3D ADJUSTMENTS</p> 	
<p>FINISHING Full HD</p> 	<p>INTERCHANGEABLE WITH: K2780</p> 	<p>COVER MATERIAL Steel</p> 	<p>NUMBER OF ROTATION AXES 5</p> 
<p>MAGNETIC COVER</p> 	<p>SUITABLE FOR</p> <p>kiker</p>	<p>Test report</p> <p>ift ROSENHEIM</p> <p>UNI EN1191:2012 Windows and doors Resistance to opening and closing</p> <p>Internal door with hinges mod. K2760 Total door weight: 60kg</p>	

EN 1670

Spray salt tested

240 hours

Evolution Series

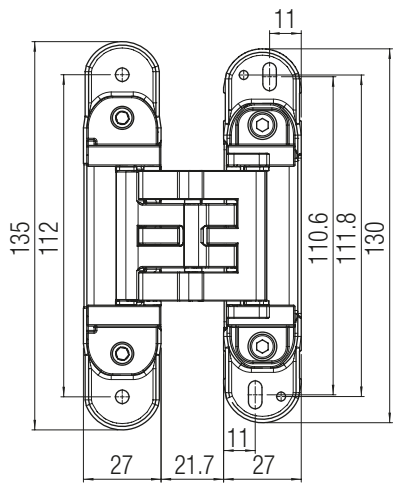
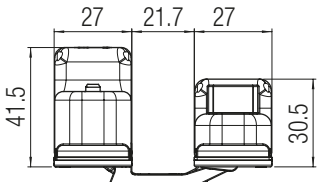
door jamb

Finishing

Colour	Item number. standard	Item number. magnetic
Polished chrome	K 2760 CL	K 2760 CL CM
Satin chrome	K 2760 CS	K 2760 CS CM
Satin nickel	K 2760 NS	K 2760 NS CM
Polished gold	K 2760 OL	K 2760 OL CM
Satin gold	K 2760 OS	K 2760 OS CM
Bronze	K 2760 BR	K 2760 BR CM
Brushed bronze		K 2760 BS CM
Polished brass	K 2760 OTL	
White	K 2760 BI	K 2760 BI CM
Black	K 2760 NO	K 2760 NO CM

For other colours please ask Krona Koblenz for feasibility

www.kronakoblenz.com



Product details:



Load capacity table (see the reading guide at page 12)

K2760 - 60 Kg - N.2 hinges												
Hinge spacing (mm)**	2000	60	60	60	60	60	60	60	60	60	58	56
	1950	60	60	60	60	60	60	60	60	59	56	54
	1900	60	60	60	60	60	60	60	60	57	55	53
	1850	60	60	60	60	60	60	60	60	58	56	53
	1800	60	60	60	60	60	60	59	56	54	52	50
	1750	60	60	60	60	60	60	57	55	53	51	49
	1700	60	60	60	60	60	58	56	53	51	49	47
	1650	60	60	60	60	60	57	54	52	50	48	46
	1600	60	60	60	60	58	55	52	50	48	46	44
	1550	60	60	60	59	56	53	51	49	47	45	43
	1500	60	60	60	57	54	52	49	47	45	43	42
1450	60	60	58	55	52	50	48	45	44	42	40	
1540	60											
	926	700	800	900	950	1000	1050	1100	1150	1200	1250	1300
Door leaf width (mm)**												

Test specifications:

- 2 hinges: Hinge spacing 1540 mm - Door leaf width 926 mm - Opening angle 0°-90°.

**With door dimensions and max opening angle different from the tested configuration and/or with the application of other devices such as, for example, door closers/bumpers/emergency handle/dropdown seal/etc. refer to the "Installation Examples". Please note that testing for these configurations is under customer's responsibility. We specify that the combinations are the result of interpolation and not of real tests, which remain under the customer's responsibility.

Standard application

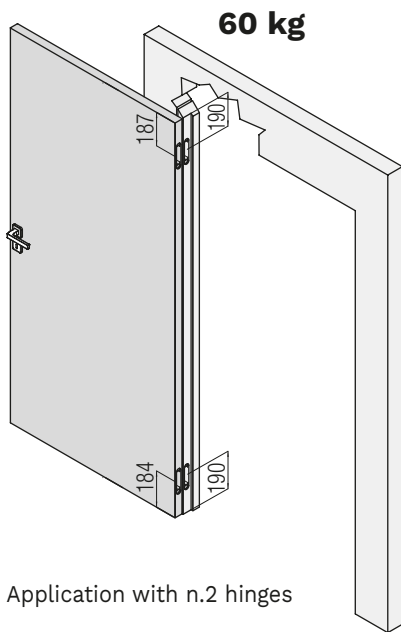

Application with n.2 hinges

Milling door/jamb

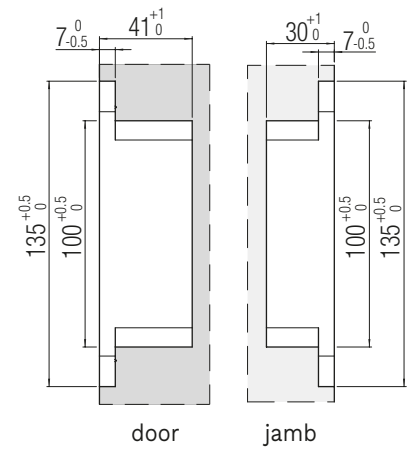

Installation of Hinge centered on the door leaf

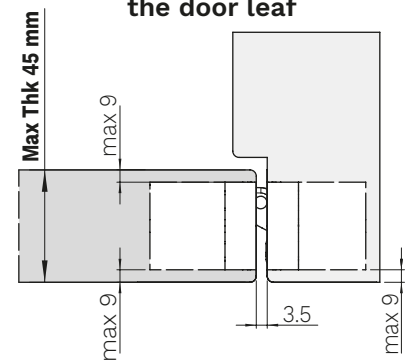

Installation of Hinge NOT centered on the door leaf

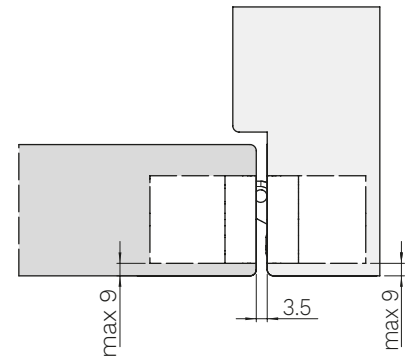



 **Fixing screws included**

The hinge fixing is ensured by using the **fixing screws** indicated in the hinge assembly instructions.

KUBICA K2780 HYBRID

PATENTED

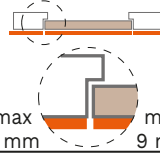
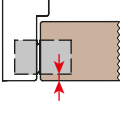
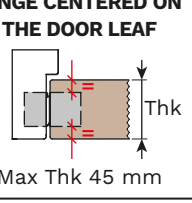
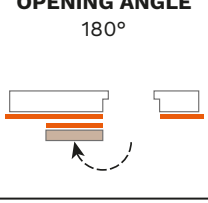
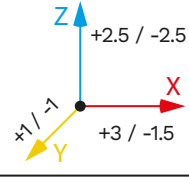
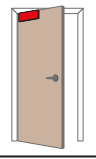
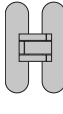
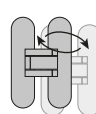
MADE IN ITALY

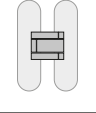
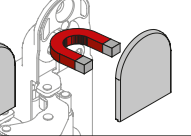
<p>HINGE MATERIAL</p> <p>Casing: Steel Adjustment body: Zamak Connecting rods: Aluminum</p>	<p>LOAD CAPACITY 80 kg (n.2 hinges)</p> 	<p>APPLICATION Cladding</p>  <p>max 9 mm</p>	<p>K DISTANCE</p>  <p>K-max 9 mm</p>
<p>HINGE CENTERED ON THE DOOR LEAF</p>  <p>Max Thk 45 mm</p>	<p>OPENING ANGLE 180°</p> 	<p>3D ADJUSTMENTS</p>  <p>Z: +2.5 / -2.5 X: +3 / -1.5 Y: +1 / -1</p>	
<p>TESTED WITH DOOR CLOSER*</p> 	<p>FINISHING Full HD</p> 	<p>INTERCHANGEABLE WITH: K2760</p> 	<p>COVER MATERIAL Steel</p> 
<p>NUMBER OF ROTATION AXES 5</p> 	<p>MAGNETIC COVER</p> 	<p>Suitable for high opening and closing environment</p>	

Product Quality



N° 21-002138-PR01 - 24/02/2022
Multi-axis, concealed hinges
EAD 020001-01-0405
Reg.-N°: 9000283

EN 1670

Spray salt tested

240 hours

*Tested with door closer models most frequently used on the market.

Evolution Series

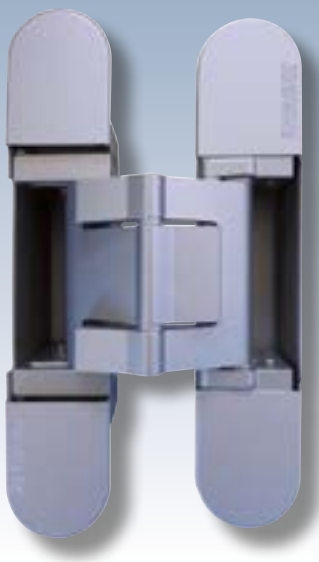
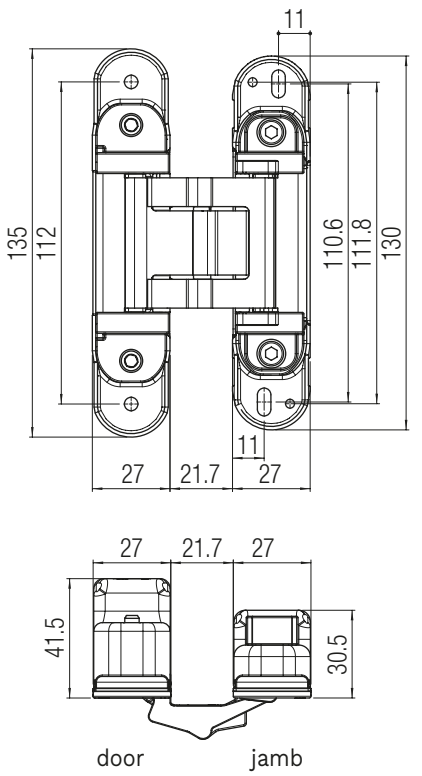
135, 112, 110.6, 111.8, 130, 27, 21.7, 11, 27, 41.5, 30.5

door jamb

Finishing		
Colour	Item number. standard	Item number. magnetic
Satin chrome	K 2780 CS	K 2780 CS CM
Umbra grey		K 2780 GO CM
Satin nickel	K 2780 NS	K 2780 NS CM
Polished gold	K 2780 OL	K 2780 OL CM
Satin gold	K 2780 OS	
Bronze		K 2780 BR CM
White	K 2780 BI	K 2780 BI CM
Black	K 2780 NO	K 2780 NO CM

For other colours please ask Krona Koblenz for feasibility



Product details:



Load capacity table (see the reading guide at page 12)

K2780 - 80 Kg - N.2 hinges													
2000	80	80	80	80	80	80	80	80	80	80	77	74	
1950	80	80	80	80	80	80	80	80	80	80	78	75	72
1900	80	80	80	80	80	80	80	80	80	79	76	73	70
1850	80	80	80	80	80	80	80	80	80	77	74	71	68
1800	80	80	80	80	80	80	80	79	75	72	69	67	65
1750	80	80	80	80	80	80	80	77	73	70	67	65	63
1700	80	80	80	80	80	80	78	74	71	68	65	63	61
1650	80	80	80	80	79	76	72	69	66	63	61	59	57
1600	80	80	80	80	77	73	70	67	64	62	60	58	56
1550	80	80	80	78	75	71	68	65	62	60	58	56	54
1500	80	80	80	76	72	69	66	63	60	58	56	54	52
1450	80	80	78	73	70	66	63	61	58	56	54	52	50
1540	80												
	926	700	800	900	950	1000	1050	1100	1150	1200	1250	1300	
		Door leaf width (mm)**											

Test specifications:

- 2 hinges: Hinge spacing 1540 mm - Door leaf width 926 mm - Opening angle 0°-90°.

**With door dimensions and max opening angle different from the tested configuration and/or with the application of other devices such as, for example, door closers/bumpers/emergency handle/dropdown seal/etc. refer to the "Installation Examples". Please note that testing for these configurations is under customer's responsibility. We specify that the combinations are the result of interpolation and not of real tests, which remain under the customer's responsibility.

Standard application

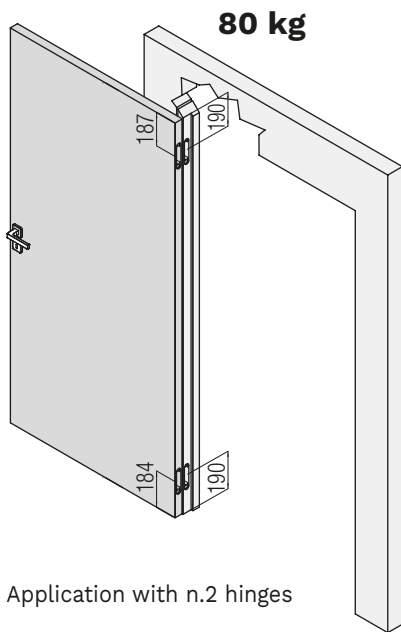

Application with n.2 hinges

Milling door/jamb

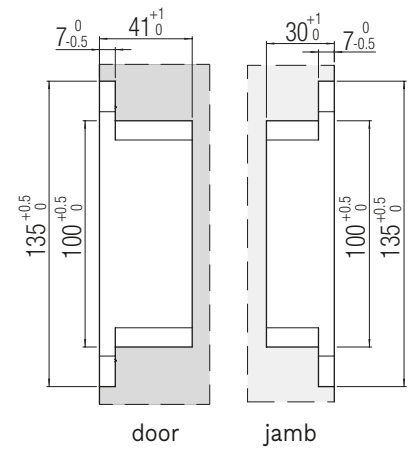

Installation of Hinge centered on the door leaf

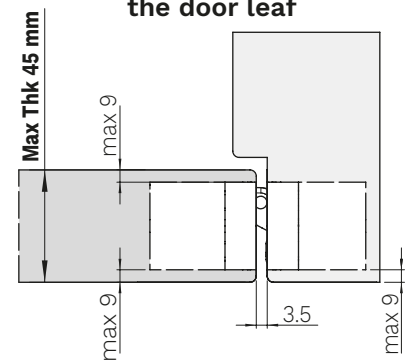

Installation of Hinge NOT centered on the door leaf

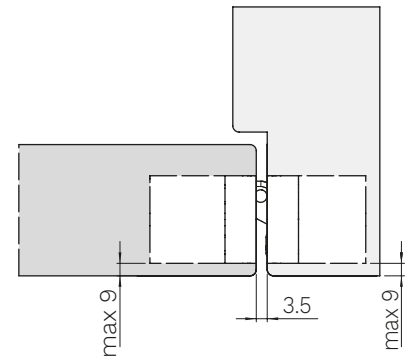







Fixing screws included

The hinge fixing is ensured by using the **fixing screws** indicated in the hinge assembly instructions.

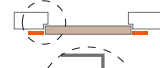
KUBICA K6380 38 HYBRID

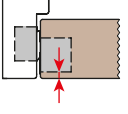
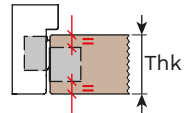
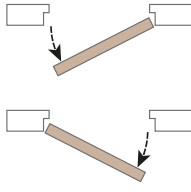
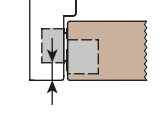
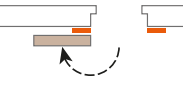
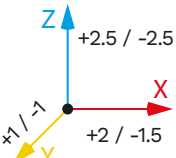
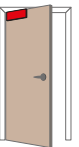
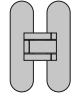
PATENTED

MADE IN ITALY

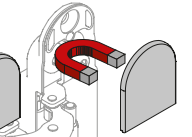
HINGE MATERIAL Casing: Steel Adjustment body: Zamak Connecting rods: Aluminum	LOAD CAPACITY 80 kg (n.2 hinges) 	APPLICATION Door flush to the trim (offset hinge)   max 12 mm	K DISTANCE  K-max 4 mm
HINGE CENTERED ON THE DOOR LEAF  Max Thk 38 mm		 max 12 mm	OPENING ANGLE 180° 
3D ADJUSTMENTS  Z: +2.5 / -2.5 X: +2 / -1.5 Y: +1 / -1	TESTED WITH DOOR CLOSER* 	FINISHING Full HD 	INTERCHANGEABLE WITH: K6360 38 
COVER MATERIAL Steel 	NUMBER OF ROTATION AXES 5 	MAGNETIC COVER 	Suitable for high opening and closing environment

*Tested with door closer models most frequently used on the market.

Evolution Series

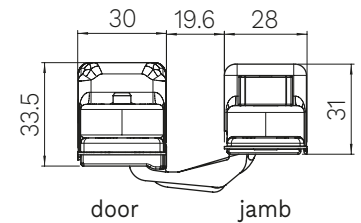
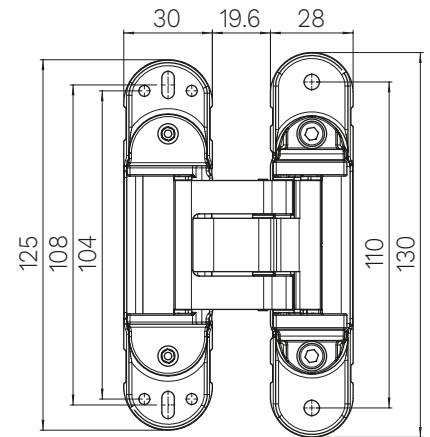

Product details:



Finishing

Colour	Item number. standard	Item number. magnetic
Polished chrome	K 6380 38 CL	
Satin chrome	K 6380 38 CS	K 6380 38 CS CM
Satin nickel	K 6380 38 NS	K 6380 38 NS CM
Polished gold	K 6380 38 OL	
Satin gold		K 6380 38 OS CM
Bronze	K 6380 38 BR	K 6380 38 BR CM
Polished brass	K 6380 38 OTL	
White	K 6380 38 BI	
Black	K 6380 38 NR	K 6380 38 NR CM

For other colours please ask Krona Koblenz for feasibility



Load capacity table (see the reading guide at page 12)

K6380 38 - 80 Kg - N.2 hinges												
2000	80	80	80	80	80	80	80	80	80	77	74	
1950	80	80	80	80	80	80	80	80	80	78	75	
1900	80	80	80	80	80	80	80	80	79	76	73	
1850	80	80	80	80	80	80	80	80	77	74	71	
1800	80	80	80	80	80	80	80	79	75	72	69	
1750	80	80	80	80	80	80	77	73	70	67	65	
1700	80	80	80	80	80	78	74	71	68	65	63	
1650	80	80	80	80	79	76	72	69	66	63	61	
1600	80	80	80	80	77	73	70	67	64	62	59	
1550	80	80	80	78	75	71	68	65	62	60	57	
1500	80	80	80	76	72	69	66	63	60	58	56	
1450	80	80	78	73	70	66	63	61	58	56	54	
1540	80											
	926	700	800	900	950	1000	1050	1100	1150	1200	1250	1300
		Door leaf width (mm)**										

Test specifications:

- 2 hinges: Hinge spacing 1540 mm - Door leaf width 926 mm - Opening angle 0°-90°.

**With door dimensions and max opening angle different from the tested configuration and/or with the application of other devices such as, for example, door closers/bumpers/emergency handle/dropdown seal/etc. refer to the "Installation Examples". Please note that testing for these configurations is under customer's responsibility. We specify that the combinations are the result of interpolation and not of real tests, which remain under the customer's responsibility.

Standard application

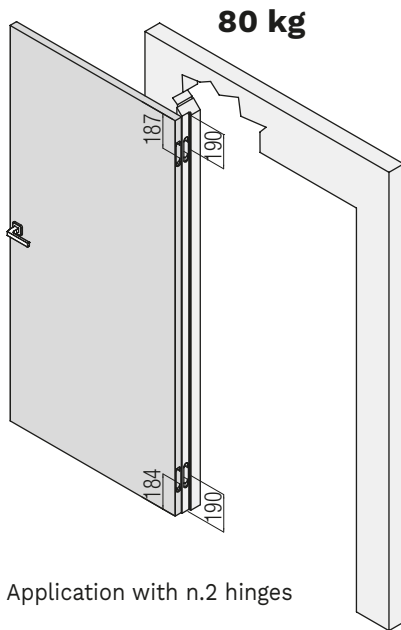

Application with n.2 hinges

Milling door/jamb

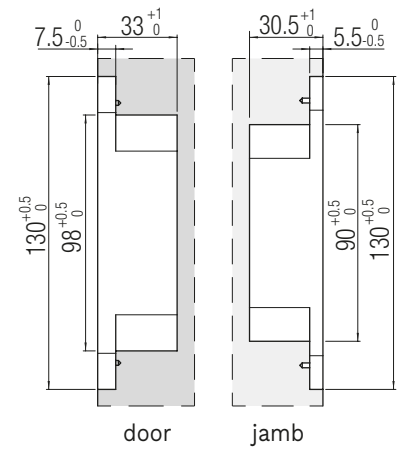

Installation of Hinge centered on the door leaf

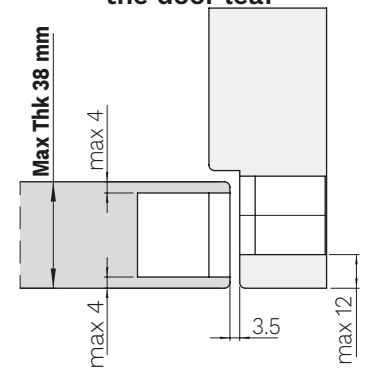

Installation of Hinge NOT centered on the door leaf

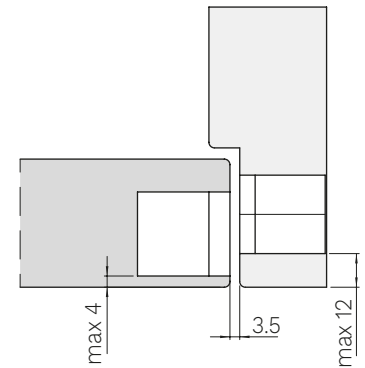





Fixing screws included

The hinge fixing is ensured by using the **fixing screws** indicated in the hinge assembly instructions.

KUBICA K6380 45 HYBRID

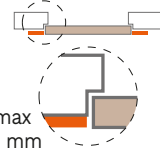
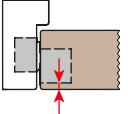
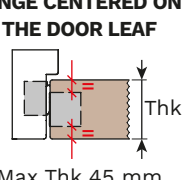
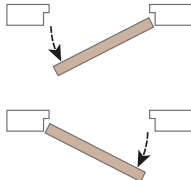
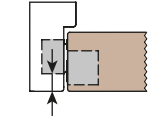
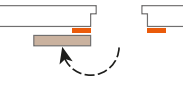
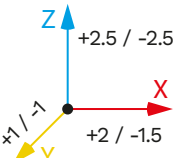
PATENTED

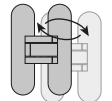
MADE IN ITALY

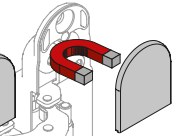
<p>HINGE MATERIAL</p> <p>Casing: Steel Adjustment body: Zamak Connecting rods: Aluminum</p>	<p>LOAD CAPACITY 80 kg (n.2 hinges)</p> 	<p>APPLICATION Door flush to the trim (offset hinge)</p>  <p>max 12 mm</p>	<p>K DISTANCE</p>  <p>K-max 4 mm</p>
<p>HINGE CENTERED ON THE DOOR LEAF</p>  <p>Max Thk 45 mm</p>		 <p>max 12 mm</p>	<p>OPENING ANGLE 180°</p> 
<p>3D ADJUSTMENTS</p>  <p>Z: +2.5 / -2.5 X: +2 / -1.5 Y: +1 / -1</p>	<p>FINISHING Full HD</p> 	<p>INTERCHANGEABLE WITH: K6360 45</p> 	<p>COVER MATERIAL Steel</p> 
<p>NUMBER OF ROTATION AXES 5</p> 	<p>MAGNETIC COVER</p> 	<p>Suitable for high opening and closing environment</p>	

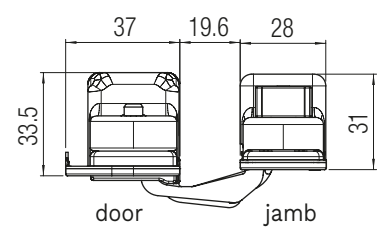
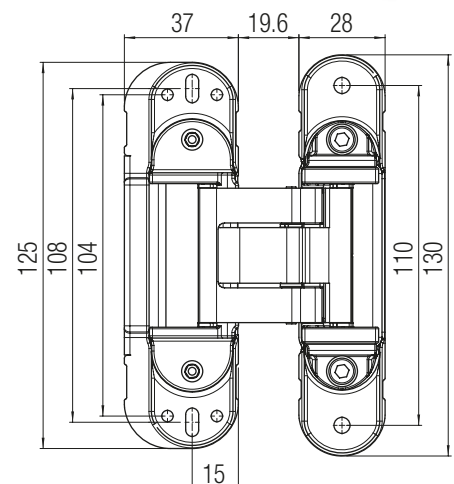

Finishing		
Colour	Item number. standard	Item number. magnetic
Polished chrome	K 6380 45 CL	
Satin chrome	K 6380 45 CS	K 6380 45 CS CM
Satin nickel	K 6380 45 NS	K 6380 45 NS CM
Polished gold	K 6380 45 OL	K 6380 45 OL CM
Satin gold		K 6380 45 OS CM
Bronze	K 6380 45 BR	K 6380 45 BR CM
Polished brass	K 6380 45 OTL	
White	K 6380 45 BI	
Black	K 6380 45 NR	K 6380 45 NR CM

For other colours please ask Krona Koblenz for feasibility

Load capacity table (see the reading guide at page 12)

K6380 45 - 80 Kg - N.2 hinges												
Hinge spacing (mm)**	2000	80	80	80	80	80	80	80	80	80	77	74
	1950	80	80	80	80	80	80	80	80	78	75	72
	1900	80	80	80	80	80	80	80	79	76	73	70
	1850	80	80	80	80	80	80	80	77	74	71	68
	1800	80	80	80	80	80	80	79	75	72	69	67
	1750	80	80	80	80	80	80	77	73	70	67	65
	1700	80	80	80	80	80	78	74	71	68	65	63
	1650	80	80	80	80	79	76	72	69	66	63	61
	1600	80	80	80	80	77	73	70	67	64	62	59
	1550	80	80	80	78	75	71	68	65	62	60	57
	1500	80	80	80	76	72	69	66	63	60	58	56
1450	80	80	78	73	70	66	63	61	58	56	54	
1540	80											
	926	700	800	900	950	1000	1050	1100	1150	1200	1250	1300
		Door leaf width (mm)**										

Test specifications:

- 2 hinges: Hinge spacing 1540 mm - Door leaf width 926 mm - Opening angle 0°-90°.

**With door dimensions and max opening angle different from the tested configuration and/or with the application of other devices such as, for example, door closers/bumpers/emergency handle/dropdown seal/etc. refer to the "Installation Examples". Please note that testing for these configurations is under customer's responsibility. We specify that the combinations are the result of interpolation and not of real tests, which remain under the customer's responsibility.

Standard application

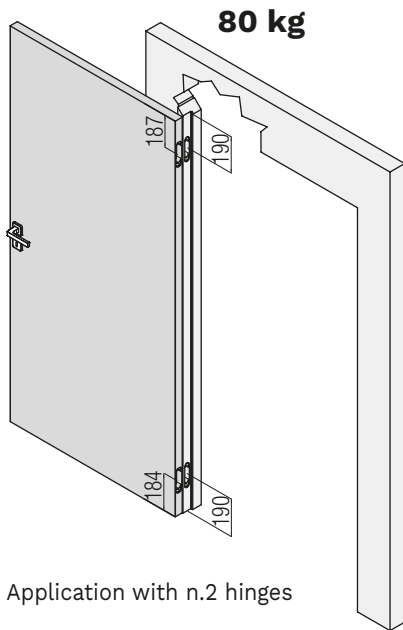

Application with n.2 hinges

Milling door/jamb

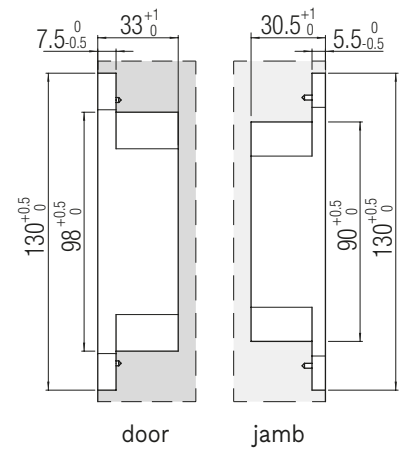

Installation of Hinge centered on the door leaf

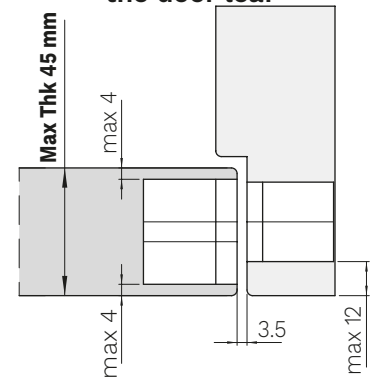

Installation of Hinge NOT centered on the door leaf

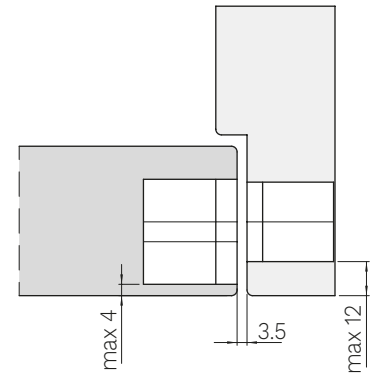

Fixing screws included

The hinge fixing is ensured by using the **fixing screws** indicated in the hinge assembly instructions.

The Classic series is represented by a **wide range of hinges made of Zamak**, a zinc alloy obtained by means of a **die-casting process** which allows to receive a **particularly compact material**.

This feature guarantees **high solidity** and **traction resistance** and allows to create very accurate surface finishes for a **high quality aesthetic result**.

The models with **7 fulcrums** typically have **greater fluidity of movement**, while those with **5 fulcrums** have **greater solidity**.

INDEX

Model	Maximum load capacity	Application	Hinge casing width on door side	K distance	Axis with assisted adjustment	Certifications	Page
KUBIKINA NEW K6100	10,5 kg 14 kg 19 kg		14 mm	max 3 mm	X		68
KUBICA KUBICENTER K6400	30 kg 45 kg		22 mm	max 4 mm	X / Y / Z		70
KUBI7 K7000	40 kg 50 kg		26 mm	max 4 mm	X / Y / Z		72
KUBICA K6200	45 kg 60 kg		23,3 mm	max 4 mm	X / Y / Z		74
KUBICA KUBIKUADRA K3000	45 kg 60 kg		31 mm	max 7,5 mm	X / Y / Z		76
KUBICA K6700	50 kg 70 kg		29 mm	max 5 mm	X / Y / Z		78
KUBICA K6300	60 kg		32 mm	max 4 mm	X / Y / Z		80
KUBICA 27 K2700	60 kg		27 mm	max 9 mm	X / Y / Z		82
KUBI7 KUBICA TWIST K2000	60 kg		30 mm	max 4 mm	X / Y / Z		84
KUBICA K5080	80 kg		28 mm	max 4 mm	X / Z		86
KUBI7 K7080	80 kg 100 kg		30 mm	max 4 mm	X / Y / Z		88
KROSS8 100 K2810	100 kg		32 mm	max 8 mm	X / Y / Z		90
KUBI7 K7120	120 kg 140 kg		32 mm	max 4 mm	X / Y / Z		92
KROSS8 160 K2816	160 kg		32 mm	max 8 mm	X / Y / Z		94
KUBI7 K7200	200 kg		32 mm	max 4 mm	X / Y / Z		96



LEGENDA

• **K distance:**

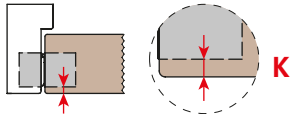

K distance is the distance between the door edge and the hinge edge.

*The **K-Max** means is the maximum K-distance that allows the correct rotation of the door from 0 ° to 180 °).*

• **Centered hinge:**

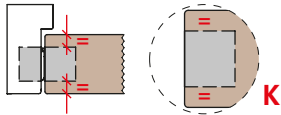

*The installation with a hinge centered on the door leaf has the advantage of making the door leaf reversible. You have a centered hinge when the **K distance** is equal to the measurement on the opposite side.*





• **Maximum load capacity:**

The maximum load capacity is referred to a door 2100 mm high, 900 mm wide and with a center to center distance 1540 mm (as the reference legislation specifies). For the measurements that differ from the indicated ones, we suggest reading the range table which you can find on each product page.

• **Axis with assisted adjustment:**

All Krona Koblenz hinges are adjustable on the 3 axes (3D): X, Y, Z. Some of these adjustments are assisted while others are manual. The index table indicates the axes with the assisted adjustment.





• **Certifications:**

-  Declaration of performance and the constancy of performance according to the European reference regulations for the product category (insights to the Certifications Chapter);
-  IFT Rosenheim laboratory which certified the conformity of the hinges to the tests necessary for the CE marking or durability tests;
-  Fire certification according to **EN 1634-1** and/or **BS476-22**;
-  Certification of conformity for the American and Canadian market according to the reference standards;
-  Certification of conformity to reference standards for the Russian market;

• **Full HD**



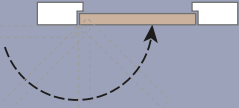

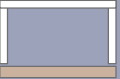



All the hinge components have the same colour.

Application			
All Krona Koblenz hinges can be installed both on the right and on the left as well as in push or pull direction depending on the desired installation			
 Door flush to the wall	 Door leaf with internal rebate	 Door leaf with external rebate	 Self closing door
 Door flush to the trim (offset hinge)	 Cladding	 Furniture	

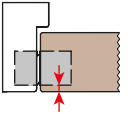
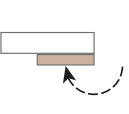
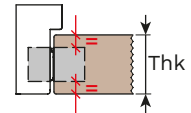
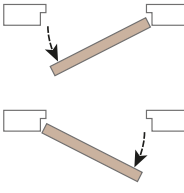
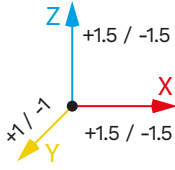
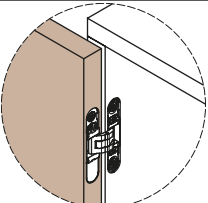
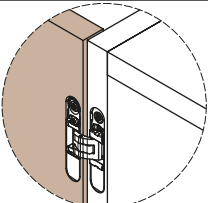
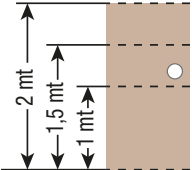
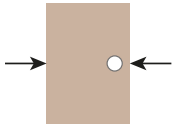
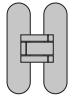
Kubikina New K6100

MADE IN ITALY

<p>HINGE MATERIAL</p> <p>Casing: Zamak Adjustment body: Acetal plastic Connecting rods: Zamak</p>	<p>LOAD CAPACITY</p> <p>10,5 kg (n.2 hinges) 14 kg (n.3 hinges) 19 kg (n.4 hinges)</p> 	<p>APPLICATION</p> <p>Furniture</p> 	<p>K DISTANCE</p>  <p>K-max 3 mm</p>
<p>OPENING ANGLE</p> <p>180°</p> 	<p>HINGE CENTERED ON THE DOOR LEAF</p>  <p>Max Thk 20 mm</p> 		<p>3D ADJUSTMENTS</p> 
<p>INSTALLATION INSIDE THE CABINET</p> 		<p>INSTALLATION OUTSIDE THE CABINET</p> 	
<p>HEIGHT OF THE SHUTTER</p>  <p>1 mt (n.2 hinges) 1,5 mt (n.3 hinges) 2 mt (n.4 hinges)</p>		<p>WIDTH OF THE SHUTTER</p>  <p>max 600 mm</p>	<p>FINISHING</p> <p>Full HD</p> 
<p>COVER MATERIAL</p> <p>Steel</p> 	<p>NUMBER OF ROTATION AXES</p> <p>5</p> 	 <p>DIN EN 15570:2008-08 test level 2</p> <p>Test report No. 00793</p>	

EN 1670

Spray salt tested

240 hours



Product details:



Classic Series

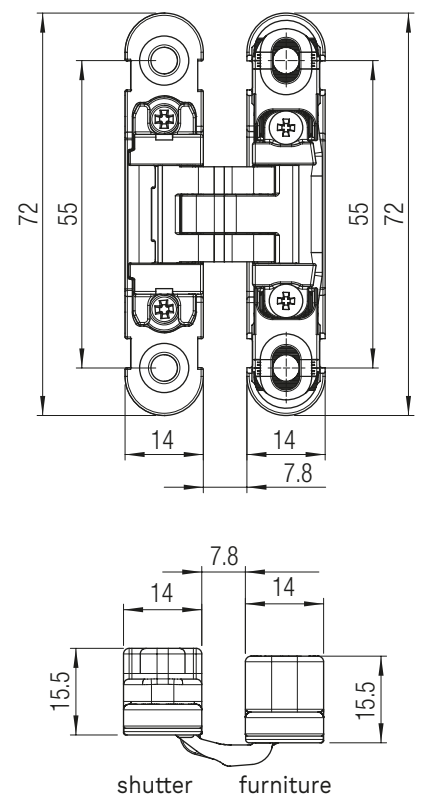
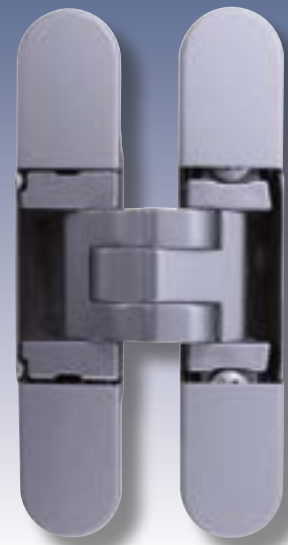

Finishing

Colour	Item number.
Satin chrome	K 6100 CS HD
White	K 6100 BI HD
Black	K 6100 NO HD

For other colours please ask Krona Koblentz for feasibility

Load capacity table (see the reading guide at page 12)

K6100 - 10,5 Kg - N.2 hinges								
Hinge spacing (mm)	850	10,5	10,5	10,5	10,5	10,5	9,0	
	750	10,5	10,5	10,5	10,5	9,2	7,9	
	650	10,5	10,5	10,5	9,5	7,9	6,8	
	550	10,5	10,5	10,5	8,0	6,7	5,7	
	450	10,5	10,5	8,1	6,5	5,4		
	350	10,5	8,2	6,1	4,9			
	820	10,5						
	600	200	300	400	500	600	700	
Door leaf width (mm)								

K6100 - 14 Kg - N.3 hinges								
Hinge spacing (mm)	1350	14,0	14,0	14,0	14,0	14,0	12,9	
	1250	14,0	14,0	14,0	14,0	14,0	12,0	
	1150	14,0	14,0	14,0	14,0	13,0	11,1	
	1050	14,0	14,0	14,0	14,0	12,0	10,3	
	950	14,0	14,0	14,0	13,2	11,0	9,4	
	850	14,0	14,0	14,0	12,0	10,5	9,0	
	1320	14						
	600	200	300	400	500	600	700	
Door leaf width (mm)								

K6100 - 19 Kg - N.4 hinges								
Hinge spacing (mm)	1850	19,0	19,0	19,0	19,0	19,0	16,3	
	1750	19,0	19,0	19,0	19,0	18,1	15,5	
	1650	19,0	19,0	19,0	19,0	17,1	14,7	
	1550	19,0	19,0	19,0	19,0	16,2	13,8	
	1450	19,0	19,0	19,0	18,2	15,2	13,0	
	1350	19,0	19,0	19,0	17,1	14,0	12,9	
	1820	19						
	600	200	300	400	500	600	700	
Door leaf width (mm)								

Tested according to EN 15570:2008 - Level 2 on furniture shutters:
 - Height 1000 mm - width 600 mm (2 hinges, 10,5kg).
 - Height 1500 mm - width 600 mm (3 hinges, 14kg).
 - Height 2000 mm - width 600 mm (4 hinges, 19kg).

With a door leaf of different dimensions from the tested configurations and/or with the application of other devices such as, for example, dampers/cables/door closers/etc., please note that the tests are to be carried out and taken under the customer's responsibility, and Krona Koblenz disclaims any liability in this regard.

Milling pattern for inside and outside the cabinet application

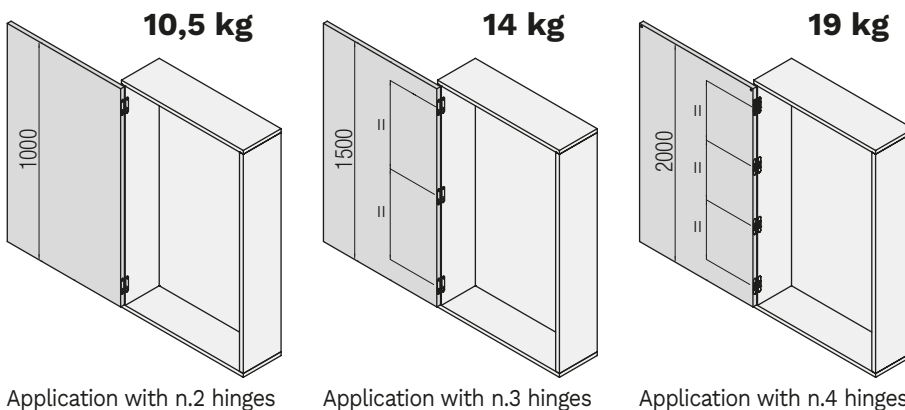

Application with n.2 hinges

Application with n.3 hinges

Application with n.4 hinges

The hinge fixing is ensured by using the fixing screws indicated in our hinge assembly instructions.

Milling shutter/furniture

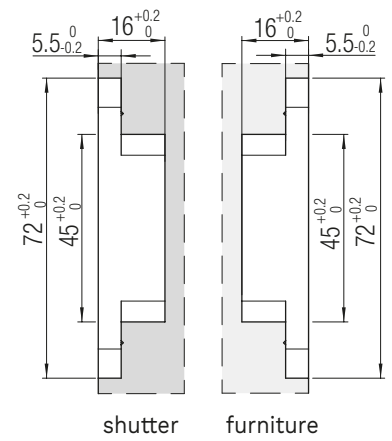

shutter furniture

Centered hinge for Inside the cabinet installation

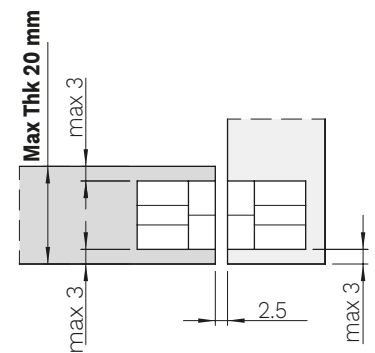

Not Centered hinge for Inside the cabinet installation

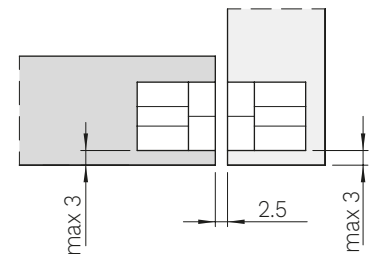

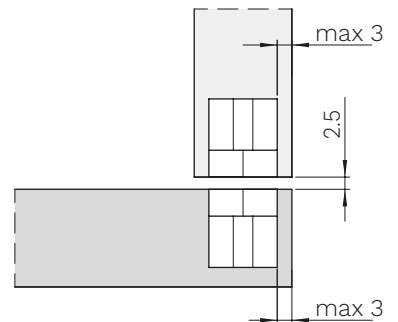

Outside the cabinet



KUBICA KubiCENTER K6400

PATENTED

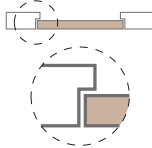
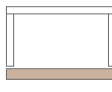
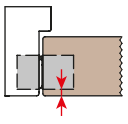
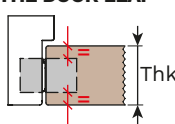
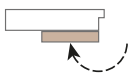
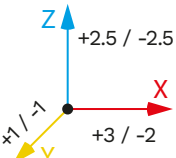
MADE IN ITALY

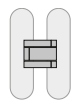
<p>HINGE MATERIAL</p> <p>Casing: Zamak Adjustment body: Acetal plastic Connecting rods: Zamak</p>	<p>LOAD CAPACITY</p> <p>30 kg (n.2 hinges) 45 kg (n.3 hinges)</p> 	<p>APPLICATION</p> <p>Flush to the wall door</p> 	<p>APPLICATION</p> <p>Furniture</p> 
<p>K DISTANCE</p>  <p>K-max 4 mm</p>	<p>HINGE CENTERED ON THE DOOR LEAF</p>  <p>Max Thk 30 mm</p>	<p>OPENING ANGLE</p> <p>180°</p> 	
<p>3D ADJUSTMENTS</p>  <p>Z +2.5 / -2.5 X +3 / -2 Y ±1</p>	<p>COVER MATERIAL</p> <p>Aluminum</p> 	<p>NUMBER OF ROTATION AXES</p> <p>5</p> 	<p>SUITABLE FOR</p> <p>kiker</p>

EN 1670

Spray salt tested

240 hours

Classic Series

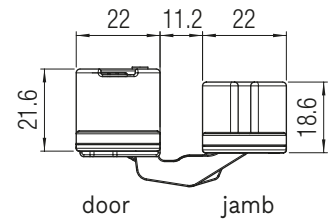
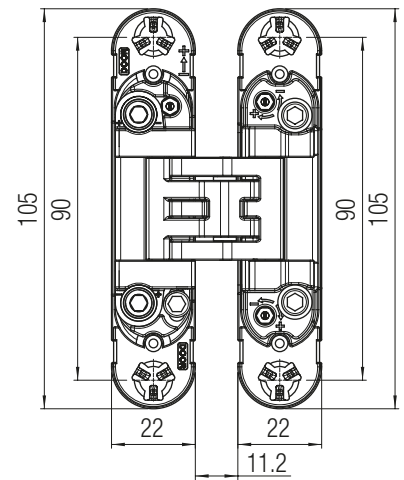
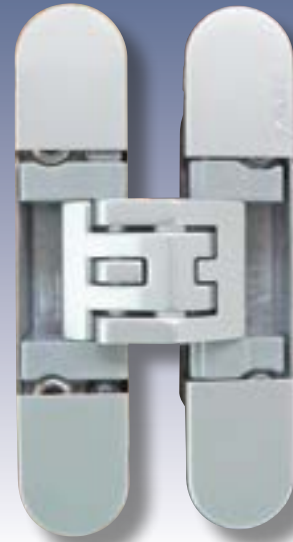

Finishing

Colour	Item number.
Satin chrome	K 6400 CS
Satin nickel	K 6400 NS
Satin gold	K 6400 OS
Black	K 6400 NO

For other colours please ask Krona Koblenz for feasibility



Product details:



Load capacity table (see the reading guide at page 12)

K6400 - 30 Kg - N.2 hinges												
2000	30	30	30	30	30	30	30	30	30	29	28	
1950	30	30	30	30	30	30	30	30	30	29	28	
1900	30	30	30	30	30	30	30	30	30	29	27	
1850	30	30	30	30	30	30	30	30	30	29	27	
1800	30	30	30	30	30	30	30	30	28	27	26	
1750	30	30	30	30	30	30	29	27	26	25	24	
1700	30	30	30	30	30	29	28	27	26	25	24	
1650	30	30	30	30	30	28	27	26	25	24	23	
1600	30	30	30	30	29	27	26	25	24	23	22	
1550	30	30	30	29	28	27	25	24	23	22	22	
1500	30	30	30	28	27	26	25	24	23	22	21	
1450	30	30	29	28	26	25	24	23	22	21	20	
1540	30											
	926	700	800	900	950	1000	1050	1100	1150	1200	1250	1300
Door leaf width (mm)**												

K6400 - 45 Kg - N.3 hinges												
2000	45	45	45	45	45	45	43	41	39	37	36	
1950	45	45	45	45	45	43	42	40	38	37	35	
1900	45	45	45	45	44	42	40	39	37	36	34	
1850	45	45	45	45	43	41	39	38	36	35	33	
1800	45	45	45	44	42	40	38	37	35	34	32	
1750	45	45	45	43	41	39	37	36	34	33	32	
1700	45	45	44	42	40	38	36	35	33	32	31	
1650	45	45	43	41	39	37	35	34	32	31	30	
1600	45	45	42	39	37	36	34	33	31	30	29	
1550	45	45	40	38	36	35	33	32	30	29	28	
1500	45	44	39	37	35	33	32	31	29	28	27	
1450	45	42	38	36	34	32	31	30	28	27	26	
1730	45											
	900	700	800	900	950	1000	1050	1100	1150	1200	1250	1300
Door leaf width (mm)**												

Test specifications:

- 2 hinges: Hinge spacing 1540 mm - Door leaf width 926 mm - Opening angle 0°-90°.
- 3 hinges: Hinge spacing 1730 mm - Door leaf width 900 mm - Opening angle 0°-90°.

**With door dimensions and max opening angle different from the tested configuration and/or with the application of other devices such as, for example, door closers/bumpers/emergency handle/dropdown seal/etc. refer to the "Installation Examples". Please note that testing for these configurations is under customer's responsibility. We specify that the combinations are the result of interpolation and not of real tests, which remain under the customer's responsibility.

Standard application

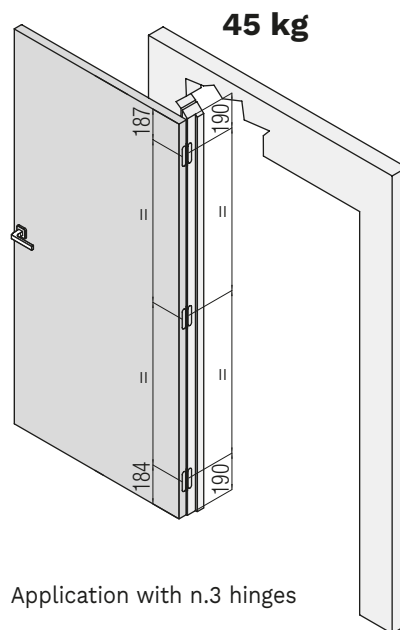
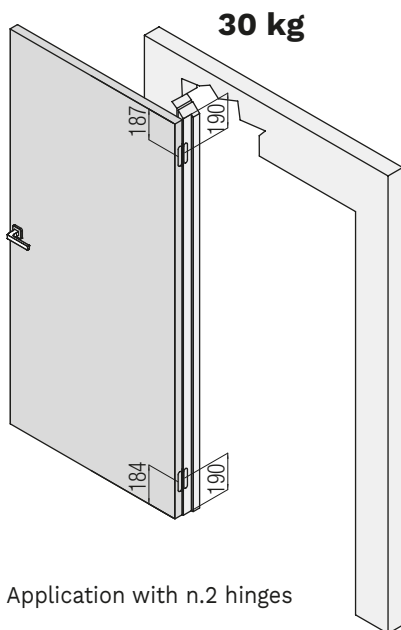

Milling door/jamb

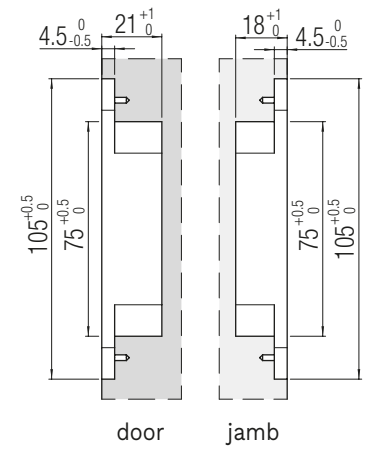

Installation of Hinge centered on the door leaf

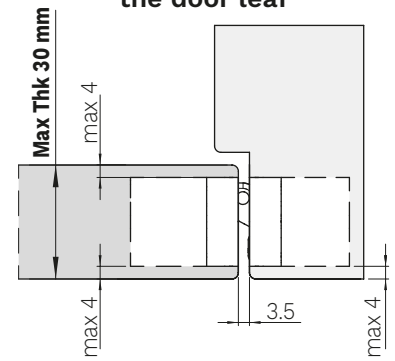



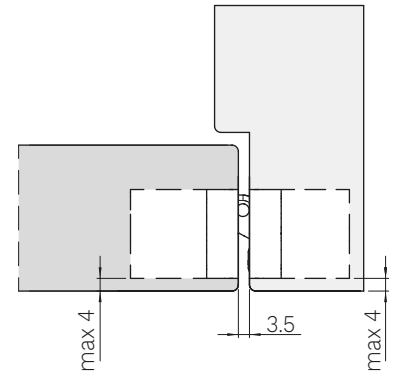

Installation of Hinge NOT centered on the door leaf

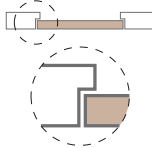
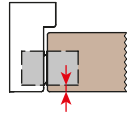
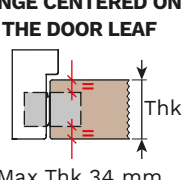
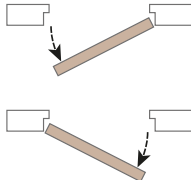
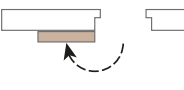
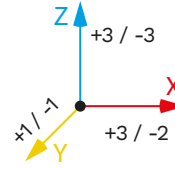

The hinge fixing is ensured by using the fixing screws indicated in our hinge assembly instructions.

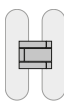
MADE IN ITALY

<p>HINGE MATERIAL</p> <p>Zamak</p>	<p>LOAD CAPACITY</p> <p>40 kg (n.2 hinges) 50 kg (n.3 hinges)</p> 	<p>APPLICATION</p> <p>Flush to the wall door</p> 	<p>K DISTANCE</p>  <p>K-max 4 mm</p>
<p>HINGE CENTERED ON THE DOOR LEAF</p>  <p>Max Thk 34 mm</p>		<p>OPENING ANGLE</p> <p>180°</p> 	<p>3D ADJUSTMENTS</p>  <p>Z +3 / -3 X +3 / -2 Y +1 / -1</p>
<p>COVER MATERIAL</p> <p>Aluminum</p> 	<p>NUMBER OF ROTATION AXES</p> <p>7</p> 	<p>SUITABLE FOR</p> <p>kiker</p>	<p>Rif. report reference N° R27182-20130522</p> 

EN 1670

Spray salt tested

240 hours

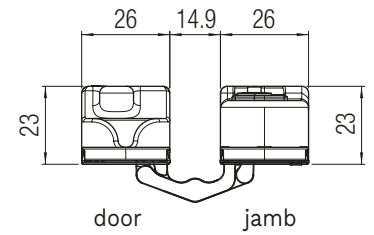
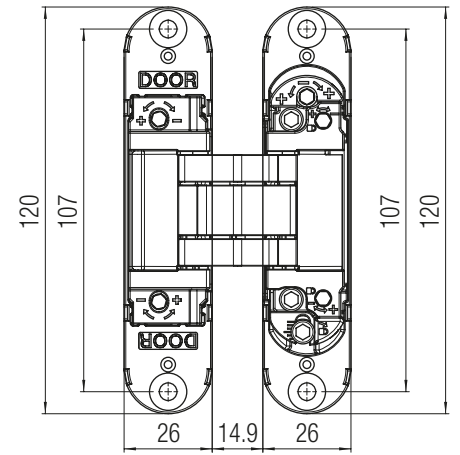
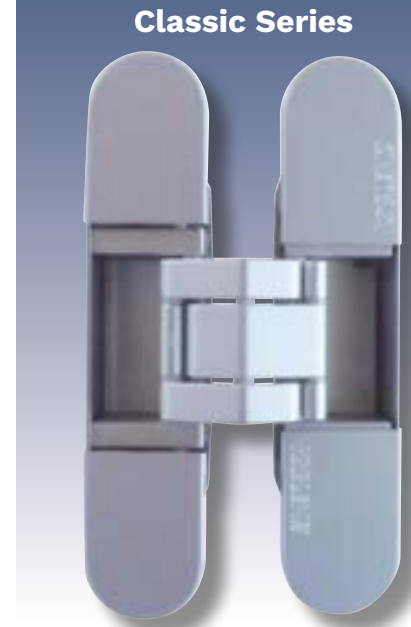

Finishing

Colour	Item number.
Satin chrome	K 7000 CS HD
Satin nickel	K 7000 NS HD
Polished gold	K 7000 OR
Black	K 7000 NO HD

For other colours please ask Krona Koblenz for feasibility



Product details:



Load capacity table (see the reading guide at page 12)

K7000 - 40 Kg - N.2 hinges												
2000	40	40	40	40	40	40	40	40	40	38	37	
1950	40	40	40	40	40	40	40	40	39	38	36	
1900	40	40	40	40	40	40	40	40	38	37	35	
1850	40	40	40	40	40	40	40	39	37	36	34	
1800	40	40	40	40	40	40	39	38	36	35	33	
1750	40	40	40	40	40	40	38	37	35	34	32	
1700	40	40	40	40	40	39	37	36	34	33	31	
1650	40	40	40	40	40	38	36	35	33	32	31	
1600	40	40	40	40	38	37	35	33	32	31	30	
1550	40	40	40	39	37	36	34	32	31	30	29	
1500	40	40	40	38	36	34	33	31	30	29	28	
1450	40	40	39	37	35	33	32	30	29	28	27	
1540	40											
	926	700	800	900	950	1000	1050	1100	1150	1200	1250	1300
Door leaf width (mm)**												

K7000 - 50 Kg - N.3 hinges												
2000	50	50	50	50	50	50	47	45	43	42	40	
1950	50	50	50	50	50	48	46	44	42	41	39	
1900	50	50	50	50	49	47	45	43	41	40	38	
1850	50	50	50	50	48	46	44	42	40	38	37	
1800	50	50	50	49	47	45	43	41	39	37	36	
1750	50	50	50	48	46	43	41	40	38	36	35	
1700	50	50	49	47	44	42	40	38	37	35	34	
1650	50	50	48	45	43	41	39	37	36	34	33	
1600	50	50	46	44	42	40	38	36	35	33	32	
1550	50	50	45	42	40	38	37	35	34	32	31	
1500	50	49	43	41	39	37	35	34	33	31	30	
1450	50	47	42	40	38	36	34	33	31	30	29	
1730	50											
	900	700	800	900	950	1000	1050	1100	1150	1200	1250	1300
Door leaf width (mm)**												

Test specifications:

- 2 hinges: Hinge spacing 1540 mm - Door leaf width 926 mm - Opening angle 0°-90°.
- 3 hinges: Hinge spacing 1730 mm - Door leaf width 900 mm - Opening angle 0°-90°.

**With door dimensions and max opening angle different from the tested configuration and/or with the application of other devices such as, for example, door closers/bumpers/emergency handle/dropdown seal/etc. refer to the "Installation Examples". Please note that testing for these configurations is under customer's responsibility. We specify that the combinations are the result of interpolation and not of real tests, which remain under the customer's responsibility.

Standard application

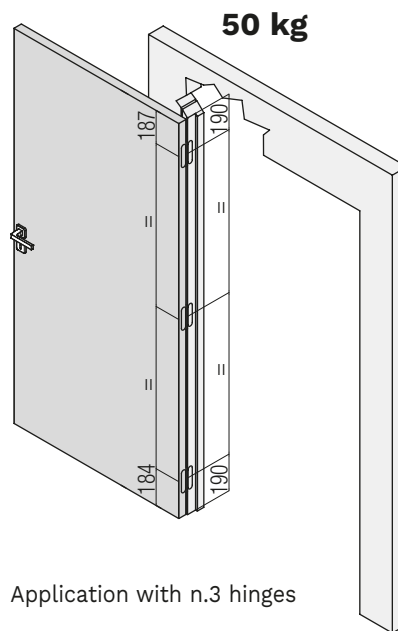
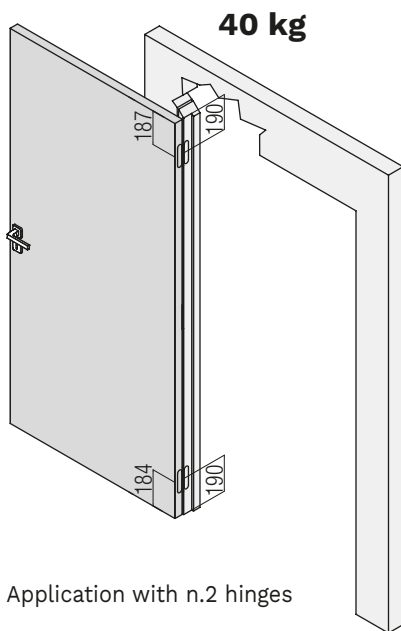

Milling door/jamb

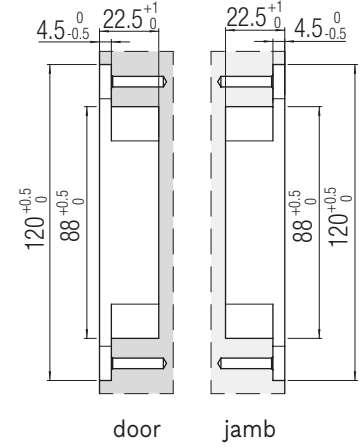

Installation of Hinge centered on the door leaf

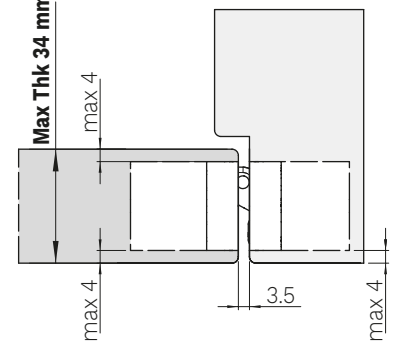

Installation of Hinge NOT centered on the door leaf

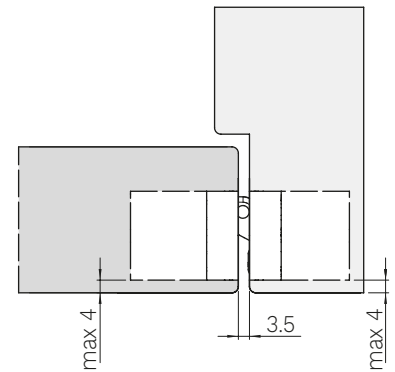

The hinge fixing is ensured by using the fixing screws indicated in our hinge assembly instructions.

KUBICA K6200

MADE IN ITALY

HINGE MATERIAL Zamak	LOAD CAPACITY 45 kg (n.2 hinges) 60 kg (n.3 hinges) 	APPLICATION Flush to the wall door 	K DISTANCE K-max 4 mm
HINGE CENTERED ON THE DOOR LEAF Max Thk 31 mm	OPENING ANGLE 180° 	3D ADJUSTMENTS Z: +2.5 / -2.5 X: +3 / -2 Y: x1 / -1	
TESTED WITH DOOR CLOSER* 	FINISHING Full HD 	COVER MATERIAL Aluminum 	NUMBER OF ROTATION AXES 5
MAGNETIC COVER 	SUITABLE FOR kiker	Rif. report reference N° R27182-20130522 	EN 1634-1 30 min.

ift Product Quality
Multi-axis, concealed hinges
EAD 020001-01-0405
Reg.-N°: 9000283

EN 1670
Spray salt tested
240 hours

CE	Krona Koblentz SpA Via Romero, 1 47853 Coriano	18							
	0757	ETA-17/0575 DOP/DOP-Nr. 004ITA/CPR/2018-02-01	2	7	2	1	1	4	0

0757-CPR-229EAD-9000283-2-2
HINGES DO NOT CONTAIN HARMFUL SUBSTANCES
KUBICA K6200
<https://www.kronakoblentz.com/certificazioni/pdf/ce-certificate-k6200-k5080-k2460-koblentz.pdf>

*Tested with door closer models most frequently used on the market.

Product details:

Classic Series

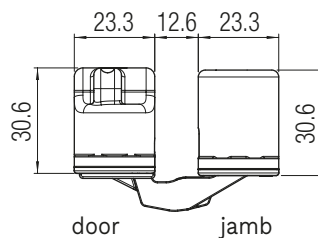
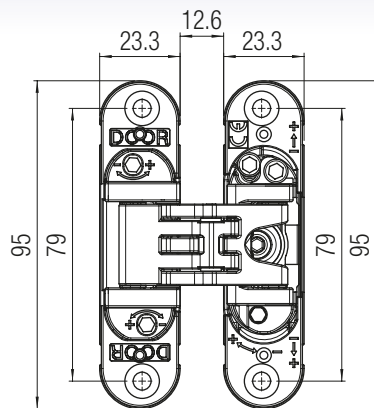

Finishing		
Colour	Item number. standard	Item number. magnetic
Anthracite grey	K 6200 AN HD	
Polished chrome	K 6200 CL HD	K 6200 CL CM
Satin chrome	K 6200 CS HD	K 6200 CS CM
Satin nickel	K 6200 NS HD	K 6200 NS CM
Polished gold	K 6200 OR HD	
Bronze	K 6200 BR HD	
White	K 6200 BI HD	
Black	K 6200 NR HD	K 6200 NR CM

For other colours please ask Krona Koblentz for feasibility



Load capacity table (see the reading guide at page 12)

K6200 - 45 Kg - N.2 hinges	
Hinge spacing (mm)**	
2000	*45 *45 *45 *45 *45 *45 *45 *43 *41 39 37 36
1950	*45 *45 *45 *45 *45 *45 *43 *42 40 38 37 35
1900	*45 *45 *45 *45 *44 *42 40 39 37 36 34
1850	*45 *45 *45 *45 *43 *41 39 38 36 35 33
1800	*45 *45 *45 *44 *42 40 38 37 35 34 32
1750	*45 *45 *45 *43 *41 39 37 36 34 33 32
1700	*45 *45 *44 *42 40 38 36 35 33 32 31
1650	*45 *45 *43 *41 39 37 35 34 32 31 30
1600	*45 *45 *42 39 37 36 34 33 31 30 29
1550	*45 *45 40 38 36 35 33 32 30 29 28
1500	*45 *44 39 37 35 33 32 31 29 28 27
1450	*45 *42 38 36 34 32 31 30 28 27 26
1730	45
	900 700 800 900 950 1000 1050 1100 1150 1200 1250 1300
	Door leaf width (mm)**

*Consider the 40 kg capacity as CE compliance

K6200 - 60 Kg - N.3 hinges	
Hinge spacing (mm)**	
2000	60 60 60 60 60 59 57 54 52 50 48
1950	60 60 60 60 60 58 55 53 51 49 47
1900	60 60 60 60 59 56 54 52 49 47 46
1850	60 60 60 60 58 55 52 50 48 46 44
1800	60 60 60 59 56 54 51 49 47 45 43
1750	60 60 60 57 55 52 50 47 46 44 42
1700	60 60 59 56 53 51 48 46 44 42 41
1650	60 60 57 54 52 49 47 45 43 41 40
1600	60 60 55 53 50 48 45 43 42 40 38
1550	60 60 54 51 48 46 44 42 40 39 37
1500	60 59 52 49 47 45 43 41 39 37 36
1450	60 57 50 48 45 43 41 39 38 36 35
1730	60
	900 700 800 900 950 1000 1050 1100 1150 1200 1250 1300
	Door leaf width (mm)**

Test specifications:

- 2 hinges: Hinge spacing 1730 mm - Door leaf width 900 mm - Opening angle 0°-90°.
- 3 hinges: Hinge spacing 1730 mm - Door leaf width 900 mm - Opening angle 0°-90°.

**With door dimensions and max opening angle different from the tested configuration and/or with the application of other devices such as, for example, door closers/bumpers/emergency handle/dropdown seal/etc. refer to the "Installation Examples". Please note that testing for these configurations is under customer's responsibility. We specify that the combinations are the result of interpolation and not of real tests, which remain under the customer's responsibility.

Standard application

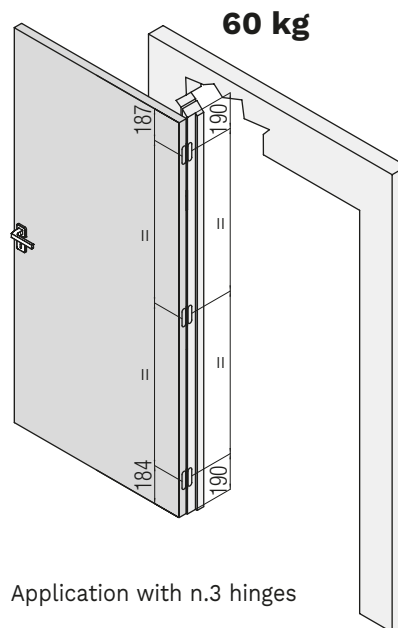
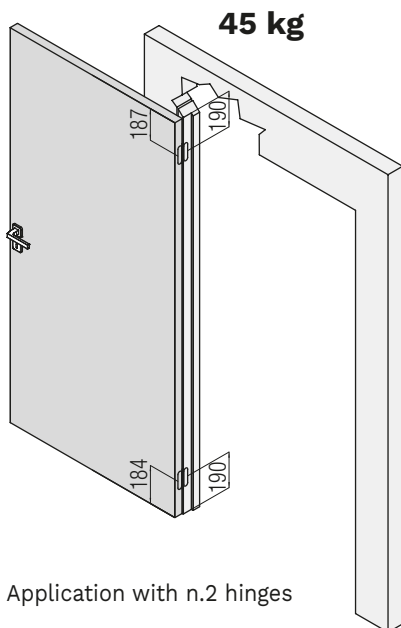

Milling door/jamb

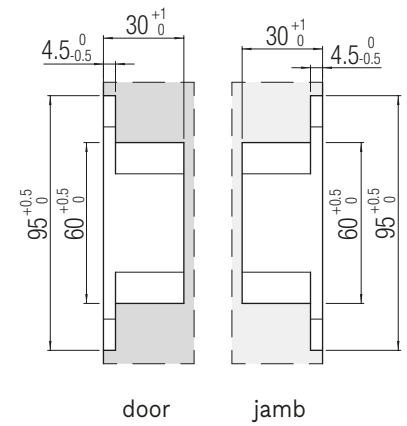

Installation of Hinge centered on the door leaf

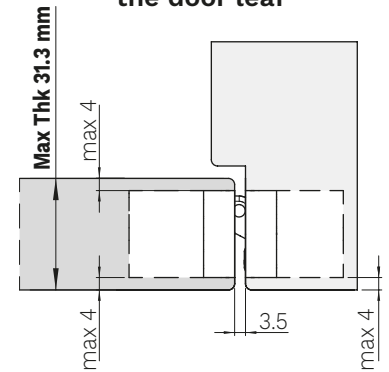

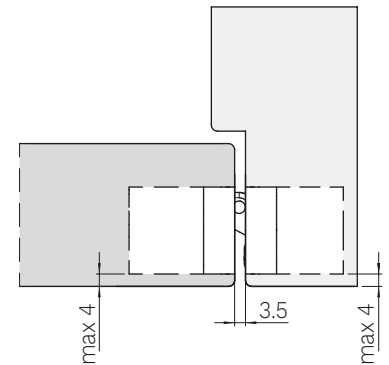

Installation of Hinge NOT centered on the door leaf



The hinge fixing is ensured by using the fixing screws indicated in our hinge assembly instructions.

KUBICA KubiKuadra K3000

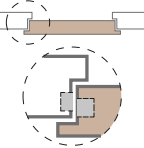
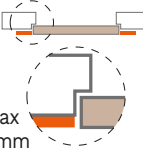
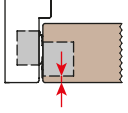
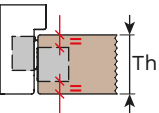
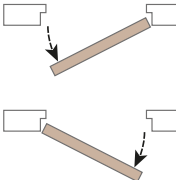
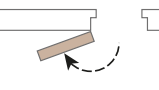
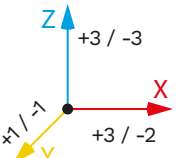
MADE IN ITALY

HINGE MATERIAL Zamak	LOAD CAPACITY 45 kg (n.2 hinges) 60 kg (n.3 hinges) 	APPLICATION Door leaf with external rebate 	APPLICATION Door flush to the trim (offset hinge)  max 14 mm
K DISTANCE  K-max 7,5 mm	HINGE CENTERED ON THE DOOR LEAF  Thk Max Thk 46 mm		OPENING ANGLE 160° 
3D ADJUSTMENTS  Z +3 / -3 X +3 / -2 Y +1 / -1	COVER MATERIAL Aluminum 	NUMBER OF ROTATION AXES 5 	EN 1670 Spray salt tested 240 hours

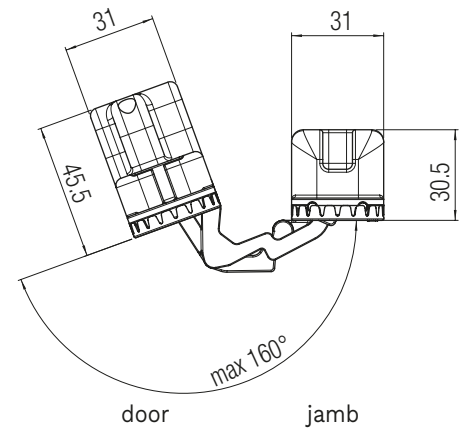
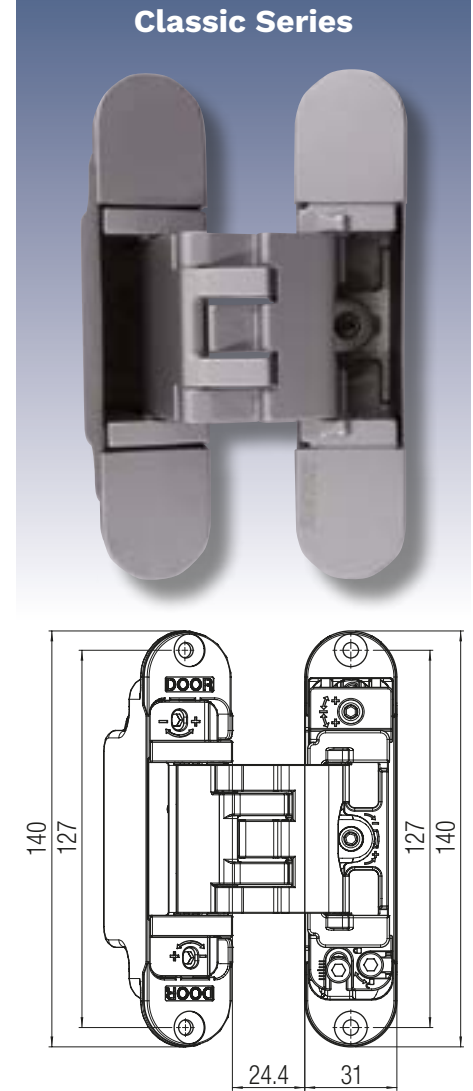

Finishing

Colour	Item number.
Satin chrome	K 3000 CS DXSX
Satin nickel	K 3000 NS DXSX
Polished gold	K 3000 OR DXSX
Black	K 3000 NO DXSX

For other colours please ask Krona Koblenz for feasibility



Load capacity table (see the reading guide at page 12)

K3000 - 45 Kg - N.2 hinges												
Hinge spacing (mm)**	2000	45	45	45	45	45	45	45	45	45	43	42
	1950	45	45	45	45	45	45	45	45	44	42	41
	1900	45	45	45	45	45	45	45	45	43	41	40
	1850	45	45	45	45	45	45	45	44	42	40	39
	1800	45	45	45	45	45	45	44	42	41	39	37
	1750	45	45	45	45	45	45	43	41	39	38	36
	1700	45	45	45	45	45	44	42	40	38	37	35
	1650	45	45	45	45	45	43	41	39	37	36	34
	1600	45	45	45	45	43	41	39	38	36	35	33
	1550	45	45	45	44	42	40	38	36	35	34	32
	1500	45	45	45	43	41	39	37	35	34	32	31
	1450	45	45	44	41	39	37	36	34	33	31	30
1540	45											
	926	700	800	900	950	1000	1050	1100	1150	1200	1250	1300
Door leaf width (mm)**												

K3000 - 60 Kg - N.3 hinges												
Hinge spacing (mm)**	2000	60	60	60	60	60	59	57	54	52	50	48
	1950	60	60	60	60	60	58	55	53	51	49	47
	1900	60	60	60	60	59	56	54	52	49	47	46
	1850	60	60	60	60	58	55	52	50	48	46	44
	1800	60	60	60	59	56	54	51	49	47	45	43
	1750	60	60	60	57	55	52	50	47	46	44	42
	1700	60	60	59	56	53	51	48	46	44	42	41
	1650	60	60	57	54	52	49	47	45	43	41	40
	1600	60	60	55	53	50	48	45	43	42	40	38
	1550	60	60	54	51	48	46	44	42	40	39	37
	1500	60	59	52	49	47	45	43	41	39	37	36
	1450	60	57	50	48	45	43	41	39	38	36	35
1730	60											
	900	700	800	900	950	1000	1050	1100	1150	1200	1250	1300
Door leaf width (mm)**												

Test specifications:

- 2 hinges: Hinge spacing 1540 mm - Door leaf width 926 mm - Opening angle 0°-90°.
- 3 hinges: Hinge spacing 1730 mm - Door leaf width 900 mm - Opening angle 0°-90°.

*With door dimensions and max opening angle different from the tested configuration and/or with the application of other devices such as, for example, door closers/bumpers/emergency handle/dropdown seal/etc. refer to the "Installation Examples". Please note that testing for these configurations is under customer's responsibility. We specify that the combinations are the result of interpolation and not of real tests, which remain under the customer's responsibility.

Standard application

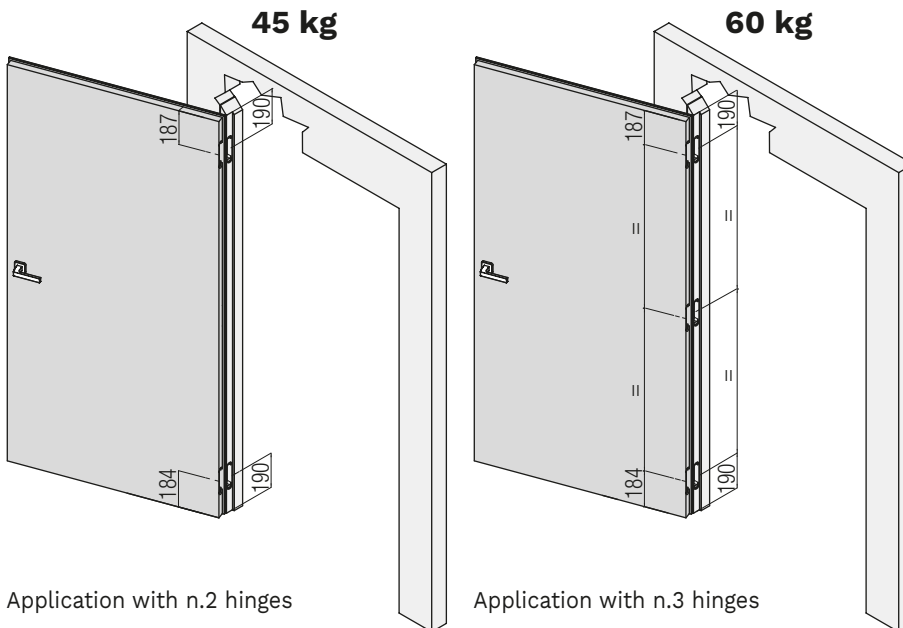

Milling door/jamb

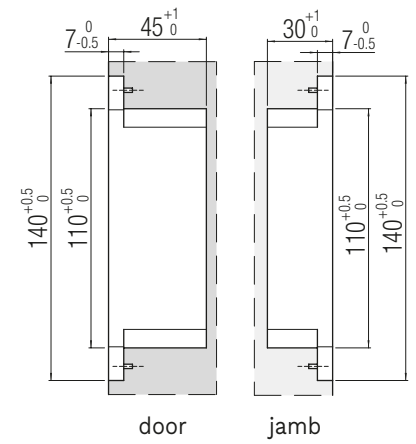

Installation of Hinge centered on the door leaf

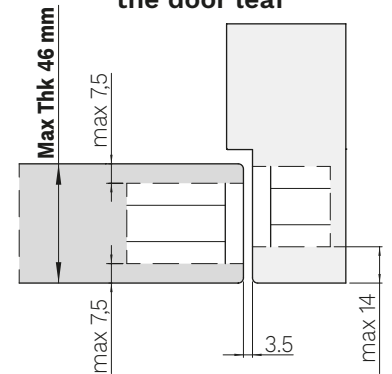

Installation of Hinge NOT centered on the door leaf

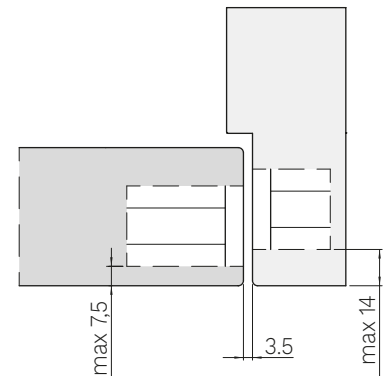

Installation for door leaf with external rebate

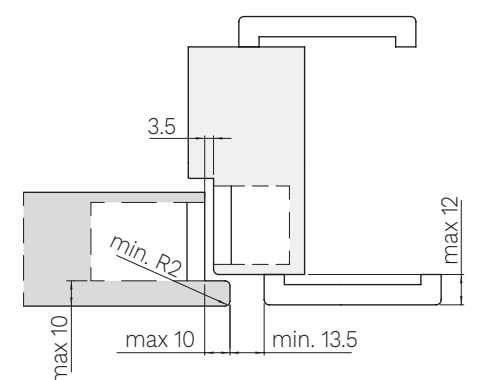





The hinge fixing is ensured by using the fixing screws indicated in our hinge assembly instructions.

KUBICA K6700

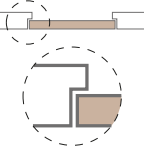
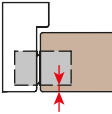
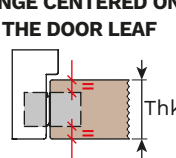
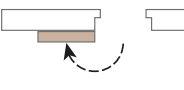
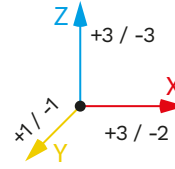
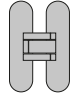
PATENTED

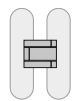
MADE IN ITALY

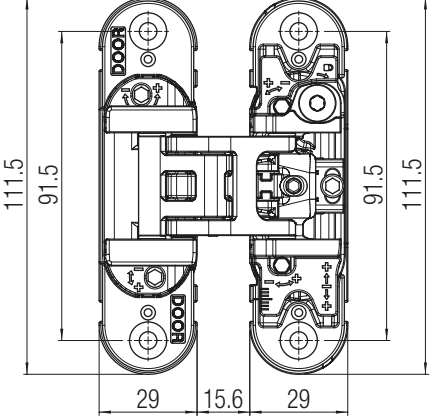
<p>HINGE MATERIAL</p> <p>Zamak</p>	<p>LOAD CAPACITY</p> <p>50 kg (n.2 hinges) 70 kg (n.3 hinges)</p> 	<p>APPLICATION</p> <p>Flush to the wall door</p> 	<p>K DISTANCE</p>  <p>K-max 5.5 mm</p>
<p>HINGE CENTERED ON THE DOOR LEAF</p>  <p>Max Thk 40 mm</p>	<p>OPENING ANGLE</p> <p>180°</p> 	<p>3D ADJUSTMENTS</p>  <p>Z +3 / -3 X +3 / -2 Y +1 / -1</p>	<p>SUITABLE FOR</p> <p>kiker</p>
<p>FINISHING</p> <p>Full HD</p> 	<p>COVER MATERIAL</p> <p>Aluminum</p>  <p>Kit of cover with screws (optional)</p>	<p>NUMBER OF ROTATION AXES</p> <p>5</p> 	<p>EN 1634-1</p>  <p>30 min.</p>
<p>Rif. report reference N° R27182-20130522</p> 	<p>EN 1670</p> <p>Spray salt tested</p> <p>240 hours</p>		

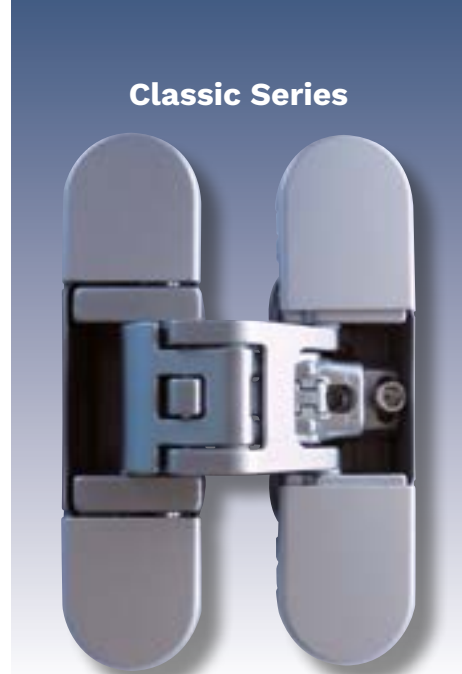

Classic Series

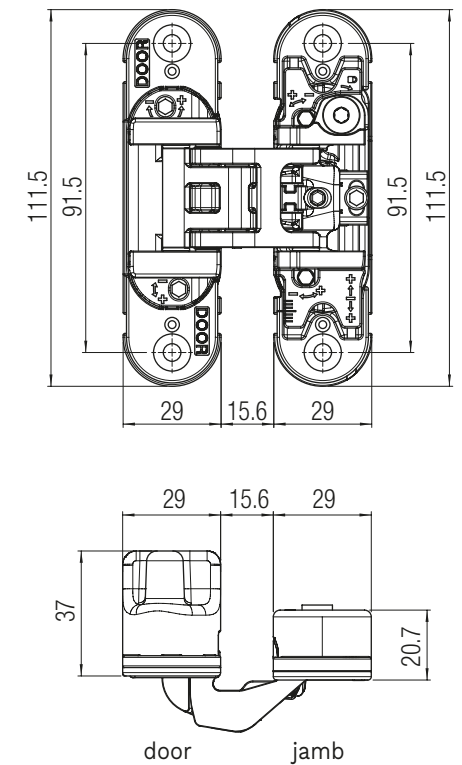

Product details:



Finishing

Colour	Item number.
Polished chrome	K 6700 CL HD
Satin chrome	K 6700 CS HD
Satin nickel	K 6700 NS HD
Polished gold	K 6700 OL HD
Black	K 6700 NO HD

For other colours please ask Krona Koblenz for feasibility



Load capacity table (see the reading guide at page 12)

K6700 - 50 Kg - N.2 hinges												
Hinge spacing (mm)**	2000	50	50	50	50	50	50	50	50	50	48	46
	1950	50	50	50	50	50	50	50	50	50	49	47
	1900	50	50	50	50	50	50	50	50	50	48	46
	1850	50	50	50	50	50	50	50	50	50	48	46
	1800	50	50	50	50	50	50	49	47	45	43	42
	1750	50	50	50	50	50	50	48	46	44	42	40
	1700	50	50	50	50	50	49	46	44	43	41	39
	1650	50	50	50	50	50	47	45	43	41	40	38
	1600	50	50	50	50	48	46	44	42	40	38	37
	1550	50	50	50	49	47	44	42	41	39	37	36
	1500	50	50	50	47	45	43	41	39	38	36	35
1450	50	50	48	46	44	42	40	38	36	35	34	
1540	50											
	926	700	800	900	950	1000	1050	1100	1150	1200	1250	1300
Door leaf width (mm)**												

K6700 - 70 Kg - N.3 hinges												
Hinge spacing (mm)**	2000	70	70	70	70	70	69	66	63	61	58	56
	1950	70	70	70	70	70	68	65	62	59	57	55
	1900	70	70	70	70	69	66	63	60	58	55	53
	1850	70	70	70	70	67	64	61	59	56	54	52
	1800	70	70	70	69	66	62	60	57	55	52	50
	1750	70	70	70	67	64	61	58	55	53	51	49
	1700	70	70	69	65	62	59	56	54	52	50	48
	1650	70	70	67	63	60	57	55	52	50	48	46
	1600	70	70	65	61	58	55	53	51	49	47	45
	1550	70	70	63	59	56	54	51	49	47	45	43
	1500	70	68	61	57	55	52	50	47	46	44	42
1450	70	66	59	56	53	50	48	46	44	42	41	
1730	70											
	900	700	800	900	950	1000	1050	1100	1150	1200	1250	1300
Door leaf width (mm)**												

Test specifications:

- 2 hinges: Hinge spacing 1540 mm - Door leaf width 926 mm - Opening angle 0°-90°.
- 3 hinges: Hinge spacing 1730 mm - Door leaf width 900 mm - Opening angle 0°-90°.

**With door dimensions and max opening angle different from the tested configuration and/or with the application of other devices such as, for example, door closers/bumpers/emergency handle/dropdown seal/etc. refer to the "Installation Examples". Please note that testing for these configurations is under customer's responsibility. We specify that the combinations are the result of interpolation and not of real tests, which remain under the customer's responsibility.

Standard application

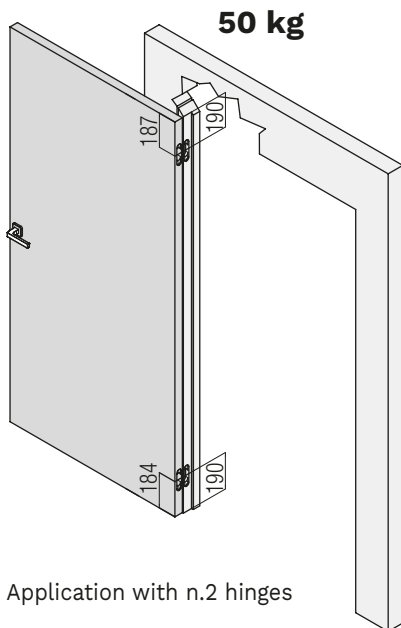

Application with n.2 hinges

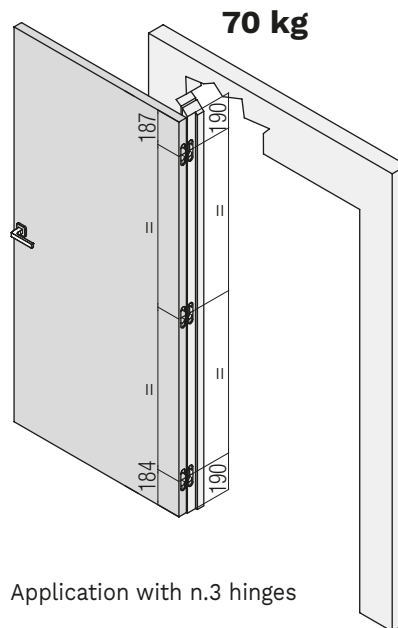

Application with n.3 hinges

Milling door/jamb

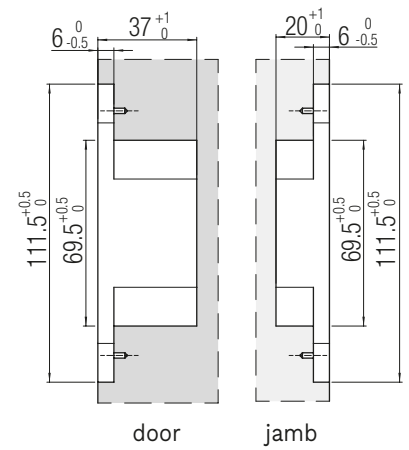

door jamb

Installation of Hinge centered on the door leaf

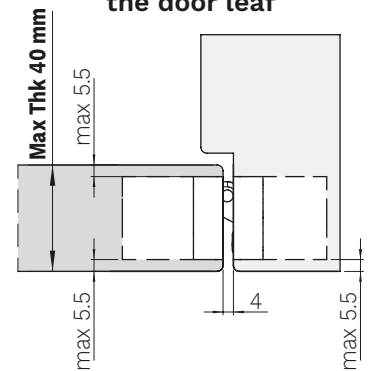



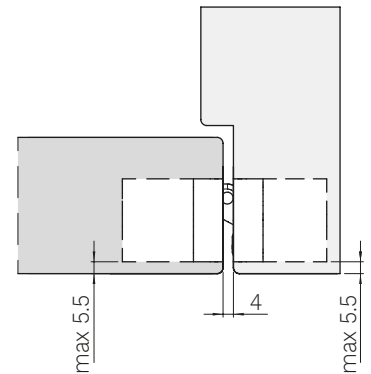

Installation of Hinge NOT centered on the door leaf

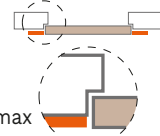
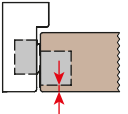
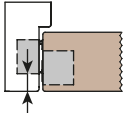
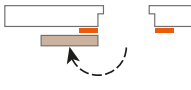
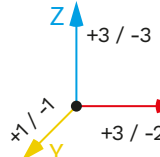

The hinge fixing is ensured by using the fixing screws indicated in our hinge assembly instructions.

KUBICA K6300

MADE IN ITALY

<p>HINGE MATERIAL</p> <p>Zamak</p>	<p>LOAD CAPACITY 60 kg (n.3 hinges)</p> 	<p>APPLICATION Door flush to the trim (offset hinge)</p>  <p>max 17 mm</p>	<p>K DISTANCE</p>  <p>K-max 4 mm</p>
 <p>max 17 mm</p>	<p>OPENING ANGLE 180°</p> 	<p>3D ADJUSTMENTS</p>  <p>Z +3 / -3 X +3 / -2 Y +1 / -1</p>	<p>COVER MATERIAL Aluminum</p> 
<p>NUMBER OF ROTATION AXES 5</p> 	<p>EN 1634-2</p>  <p>30 min.</p>		

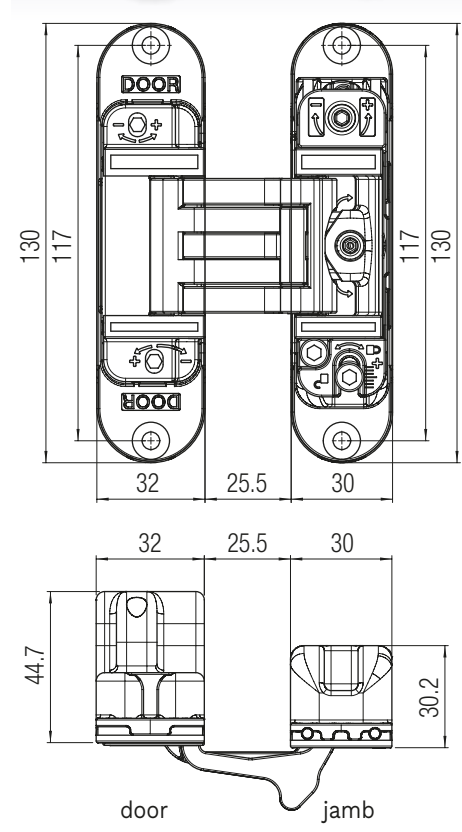

Product details:



Classic Series

Finishing	
Colour	Item number.
Satin chrome	K 6300 20CS
Satin nickel	K 6300 21NS
White	K 6300 BI
Black	K 6300 NO

For other colours please ask Krona Koblenz for feasibility

Load capacity table (see the reading guide at page 12)

K6300 - 60 Kg - N.3 hinges													
Hinge spacing (mm)**	2000	60	60	60	60	60	59	57	54	52	50	48	
	1950	60	60	60	60	60	58	55	53	51	49	47	
	1900	60	60	60	60		59	56	54	52	49	46	
	1850	60	60	60	60		58	55	52	50	48	44	
	1800	60	60	60	60	59	56	54	51	49	47	45	43
	1750	60	60	60	60	57	55	52	50	47	46	44	42
	1700	60	60	59	56	53	51	48	46	44	42	41	40
	1650	60	60	57	54	52	49	47	45	43	41	40	38
	1600	60	60	55	53	50	48	45	43	42	40	38	37
	1550	60	60	54	51	48	46	44	42	40	39	37	36
	1500	60	59	52	49	47	45	43	41	39	37	36	35
	1450	60	57	50	48	45	43	41	39	38	36	35	35
	1730	60											
	900	700	800	900	950	1000	1050	1100	1150	1200	1250	1300	
	Door leaf width (mm)**												

Test specifications:

- 3 hinges: Hinge spacing 1730 mm - Door leaf width 900 mm - Opening angle 0°-90°.

**With door dimensions and max opening angle different from the tested configuration and/or with the application of other devices such as, for example, door closers/bumpers/emergency handle/dropdown seal/etc. refer to the "Installation Examples". Please note that testing for these configurations is under customer's responsibility. We specify that the combinations are the result of interpolation and not of real tests, which remain under the customer's responsibility.

Standard application

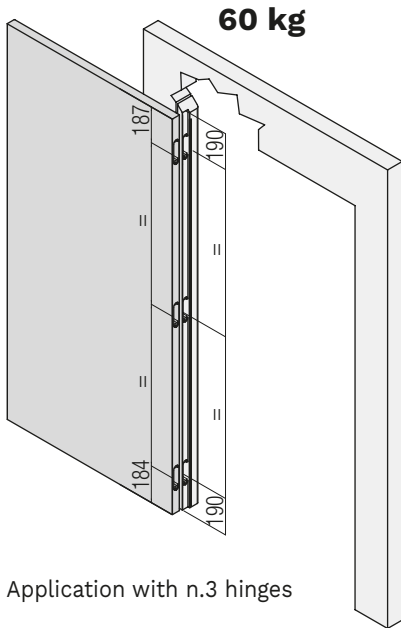

Milling door/jamb

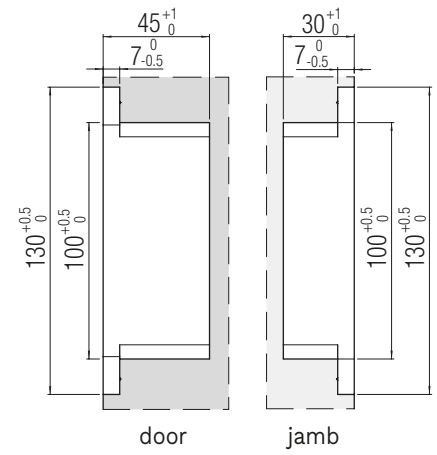

Installation of Hinge NOT centered on the door leaf

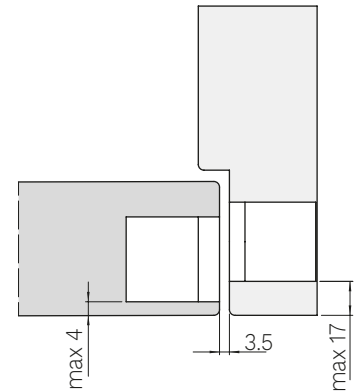





Fixing screws included

The hinge fixing is ensured by using the **fixing screws** indicated in the hinge assembly instructions.

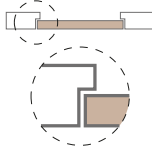
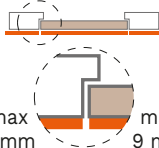
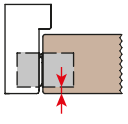
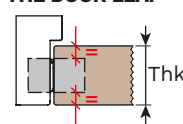
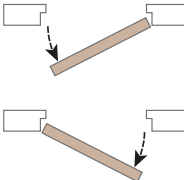
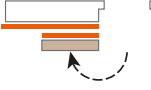
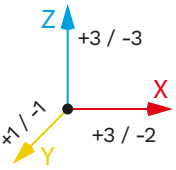
KUBICA KUBICA ²⁷ K2700

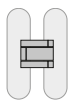
MADE IN ITALY

HINGE MATERIAL Zamak	LOAD CAPACITY 60 kg (n.3 hinges) 	APPLICATION Flush to the wall door 	APPLICATION Cladding  max 9 mm max 9 mm
K DISTANCE  K-max 9 mm	HINGE CENTERED ON THE DOOR LEAF  Thk Max Thk 45 mm		OPENING ANGLE 180° 
3D ADJUSTMENTS  Z +3 / -3 X +3 / -2 Y +1 / -1	TESTED WITH DOOR CLOSER* 	COVER MATERIAL Aluminum 	NUMBER OF ROTATION AXES 5 
SUITABLE FOR 	EN 1670 Spray salt tested 240 hours		

*Tested with door closer models most frequently used on the market.

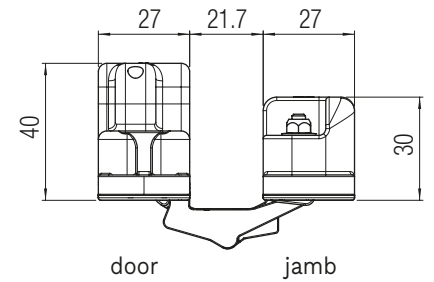
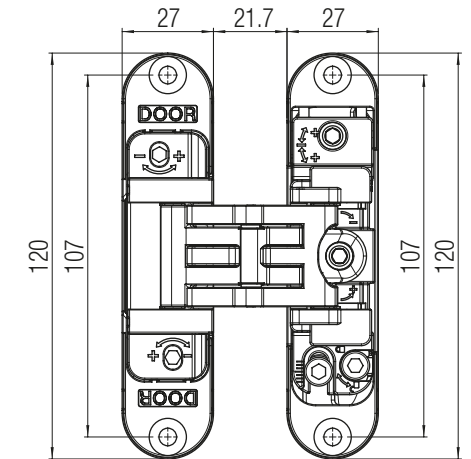

Finishing

Colour	Item number.
Polished chrome	K 2700 CL DXSX
Satin chrome	K 2700 CS DXSX
Satin nickel	K 2700 NS DXSX
Polished gold	K 2700 OR DXSX
Black	K 2700 NO DXSX

For other colours please ask Krona Koblenz for feasibility



Product details:



Load capacity table (see the reading guide at page 12)

K2700 - 60 Kg - N.3 hinges												
Hinge spacing (mm)**	2000	60	60	60	60	60	59	57	54	52	50	48
	1950	60	60	60	60	60	58	55	53	51	49	47
	1900	60	60	60	60	59	56	54	52	49	47	46
	1850	60	60	60	60	58	55	52	50	48	46	44
	1800	60	60	60	59	56	54	51	49	47	45	43
	1750	60	60	60	57	55	52	50	47	46	44	42
	1700	60	60	59	56	53	51	48	46	44	42	41
	1650	60	60	57	54	52	49	47	45	43	41	40
	1600	60	60	55	53	50	48	45	43	42	40	38
	1550	60	60	54	51	48	46	44	42	40	39	37
	1500	60	59	52	49	47	45	43	41	39	37	36
	1450	60	57	50	48	45	43	41	39	38	36	35
	1730	60										
		900	700	800	900	950	1000	1050	1100	1150	1200	1250
Door leaf width (mm)**												

Test specifications:

- 3 hinges: Hinge spacing 1730 mm - Door leaf width 900 mm - Opening angle 0°-90°.

**With door dimensions and max opening angle different from the tested configuration and/or with the application of other devices such as, for example, door closers/bumpers/emergency handle/dropdown seal/etc. refer to the "Installation Examples". Please note that testing for these configurations is under customer's responsibility. We specify that the combinations are the result of interpolation and not of real tests, which remain under the customer's responsibility.

Standard application

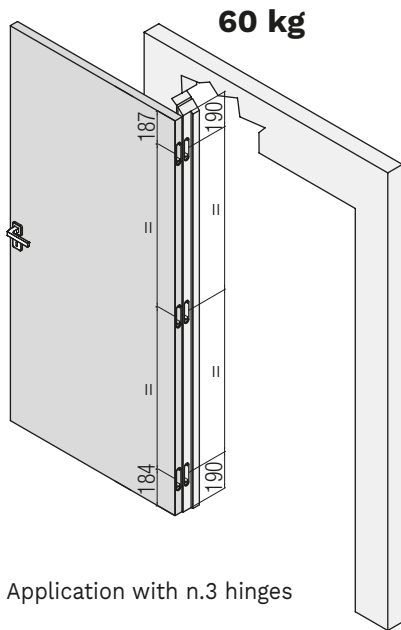

Milling door/jamb

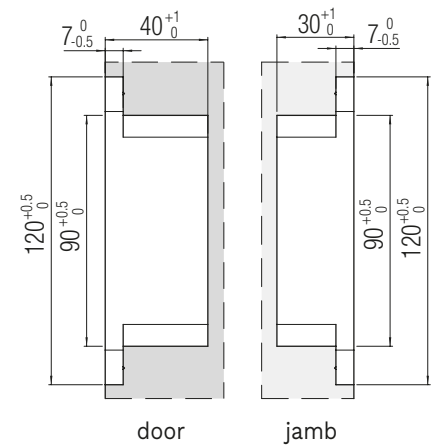

Installation of Hinge centered on the door leaf

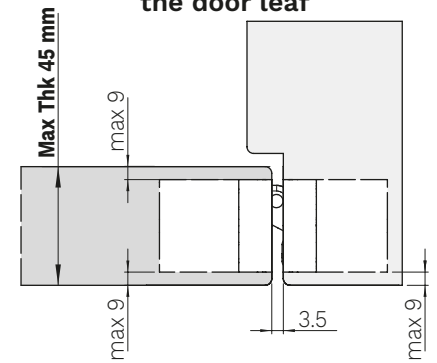



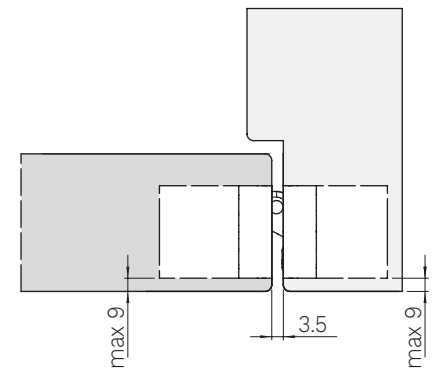

Installation of Hinge NOT centered on the door leaf

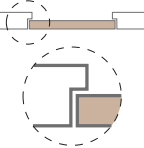
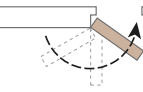
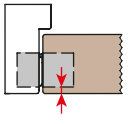
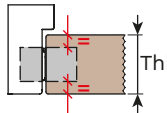
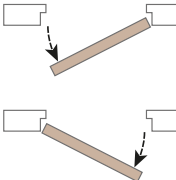
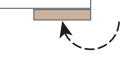
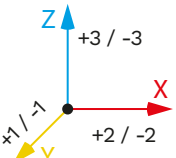

The hinge fixing is ensured by using the fixing screws indicated in our hinge assembly instructions.

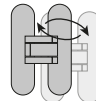
MADE IN ITALY

<p>HINGE MATERIAL</p> <p>Zamak</p>	<p>LOAD CAPACITY 60 kg (n.3 hinges)</p> 	<p>APPLICATION Flush to the wall door</p> 	<p>APPLICATION Self closing door</p>  <p>Adjustable self closing speed</p>
<p>K DISTANCE</p>  <p>K-max 4 mm</p>	<p>HINGE CENTERED ON THE DOOR LEAF</p>  <p>Max Thk 38 mm</p>		<p>OPENING ANGLE 180°</p> 
<p>3D ADJUSTMENTS</p>  <p>+3 / -3 +2 / -2 x1 / -1</p>	<p>FINISHING Full HD</p> 	<p>INTERCHANGEABLE WITH: K7080 / K7316</p> 	<p>COVER MATERIAL Aluminum</p> 
<p>NUMBER OF ROTATION AXES 7</p> 	<p>EN 1670</p> <p>Spray salt tested</p> <p>240 hours</p>		

Classic Series

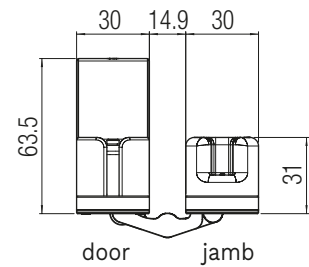
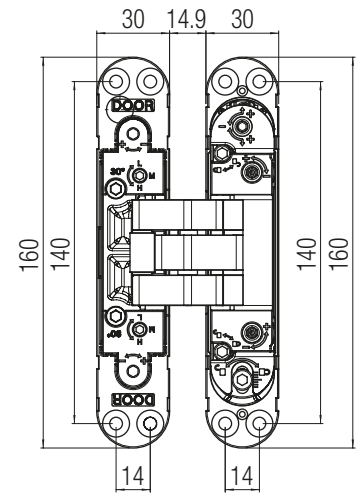
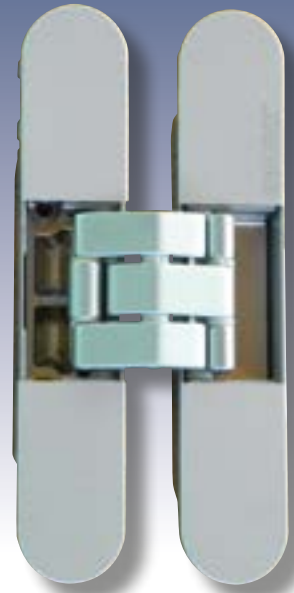

Finishing

Colour	Item number.
Satin chrome	K 2000 CS HD
Satin nickel	K 2000 NS HD

For other colours please ask Krona Koblenz for feasibility



Product details:



Load capacity table (see the reading guide at page 12)

Hinge spacing (mm)**		K2000 - 60 Kg - N.3 hinges							
		900	700	800	900	950	1000	1050	1100
2000	60	60	60	60	60	60	59	57	
1950	60	60	60	60	60	60	58	55	
1900	60	60	60	60	60	59	56	54	
1850	60	60	60	60	60	58	55	52	
1800	60	60	60	60	59	56	54	51	
1750	60	60	60	60	57	55	52	50	
1700	60	60	59	56	53	51	48		
1650	60	60	57	54	52	49	47		
1600	60	60	55	53	50	48	45		
1550	60	60	54	51	48	46	44		
1500	60	59	52	49	47	45	43		
1450	60	57	50	48	45	43	41		
1730	60								
		900	700	800	900	950	1000	1050	1100
		Door leaf width (mm)**							

Test specifications:

- 3 hinges: Hinge spacing 1730 mm - Door leaf width 900 mm - Opening angle 0°-90°.

**With door dimensions and max opening angle different from the tested configuration and/or with the application of other devices such as, for example, door closers/bumpers/emergency handle/dropdown seal/etc. refer to the "Installation Examples". Please note that testing for these configurations is under customer's responsibility. We specify that the combinations are the result of interpolation and not of real tests, which remain under the customer's responsibility.

Standard application

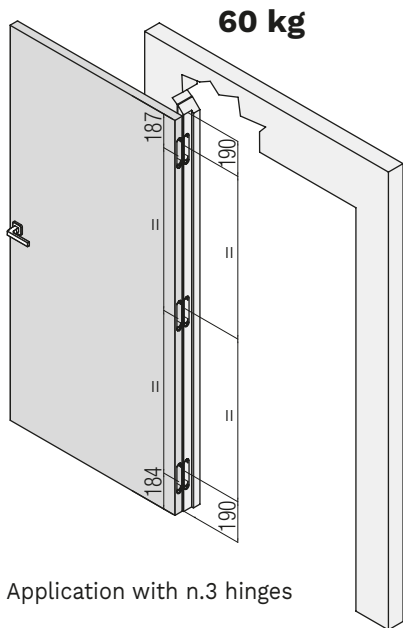

Application with n.3 hinges

Milling door/jamb

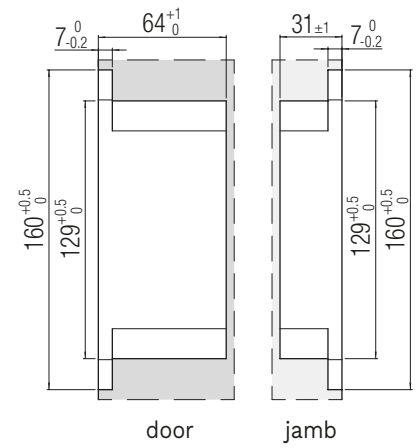

Installation of Hinge centered on the door leaf

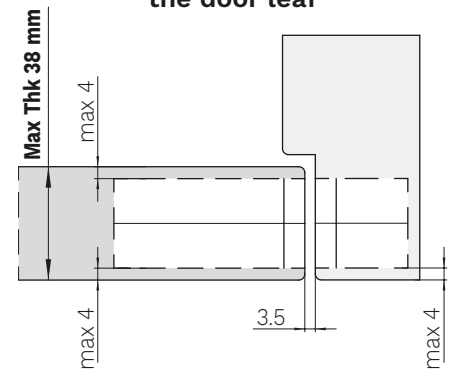

Installation of Hinge NOT centered on the door leaf

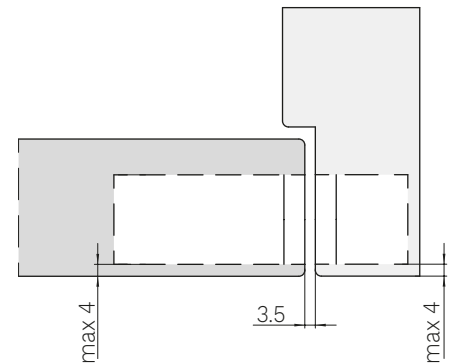





Fixing screws included

The hinge fixing is ensured by using the **fixing screws** indicated in the hinge assembly instructions.

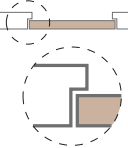
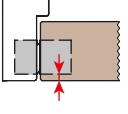
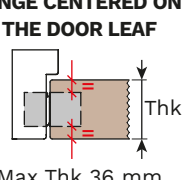
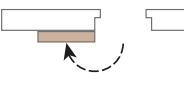
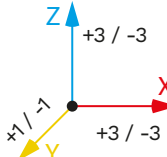
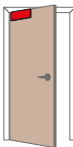
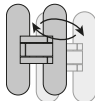
KUBICA K5080

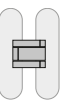
MADE IN ITALY

<p>HINGE MATERIAL</p> <p>Zamak</p>	<p>LOAD CAPACITY 80 kg (n.2 hinges)</p> 	<p>APPLICATION Flush to the wall door</p> 	<p>K DISTANCE</p>  <p>K-max 4 mm</p>
<p>HINGE CENTERED ON THE DOOR LEAF</p>  <p>Max Thk 36 mm</p>	<p>OPENING ANGLE 180°</p> 	<p>3D ADJUSTMENTS</p>  <p>Z +3 / -3 X +3 / -3 Y +1 / -1</p>	<p>TESTED WITH DOOR CLOSER*</p> 
<p>INTERCHANGEABLE WITH: K8080 / K8120</p> 	<p>COVER MATERIAL Aluminum</p>  <p>Cover with screws</p>	<p>NUMBER OF ROTATION AXES 5</p> 	<p>SUITABLE FOR</p> <p>kiker</p>
<p>Suitable for high opening and closing environment</p> <div style="border: 1px solid black; padding: 5px;">  <p>Product Quality Multi-axis, concealed hinges EAD 020001-01-0405 Reg.-N°: 9000283</p> </div>			

 0757	Krona Koblentz SpA Via Romero, 1 47853 Coriano	18
	ETA-17/0575 DOP/DOP-Nr. 0031TA/CPRI/2018-02-01	3 7 4 1 1 4 0 11
0157-CPR-229EAD-9000283-2-2 HINGES DO NOT CONTAIN HARMFUL SUBSTANCES KUBICA K5080 https://www.kronakoblentz.com/certificazioni/pdf/ce-certificate-k6200-k5080-k2460-koblentz.pdf		

Rif. report reference N° R27182-20130522



EN 1634-1

30 min.

EN 1670

Spray salt tested

240 hours

*Tested with door closer models most frequently used on the market.



Classic Series

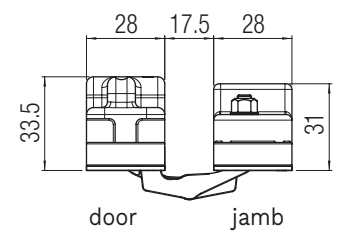
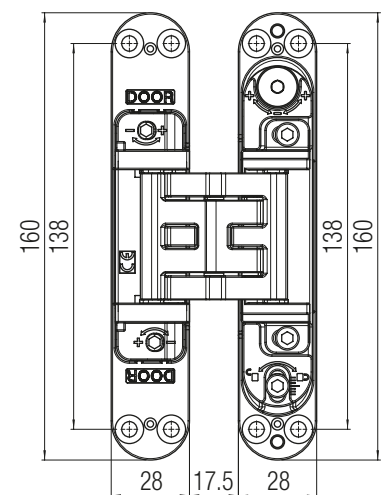
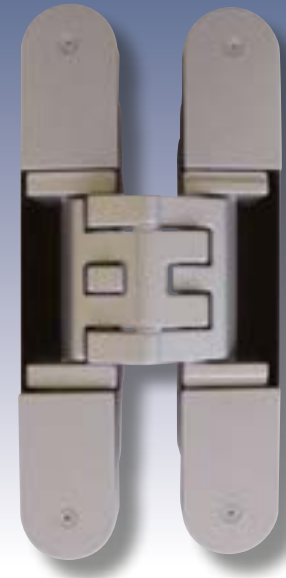

Finishing

Colour	Item number.
Anthracite grey	K 5080 AN
Antique bronze	K 5080 BA
Satin chrome	K 5080 CS DXSX
Satin nickel	K 5080 NS DXSX
Polished gold	K 5080 OR DXSX
Satin gold	K 5080 OS DXSX
Bronze	K 5080 BR DXSX
Black	K 5080 NR

For other colours please ask Krona Koblentz for feasibility

Load capacity table (see the reading guide at page 12)

K5080 - 80 Kg - N.2 hinges												
Hinge spacing (mm)**	2000	80	80	80	80	80	80	80	80	80	77	74
	1950	80	80	80	80	80	80	80	80	78	75	72
	1900	80	80	80	80	80	80	80	79	76	73	70
	1850	80	80	80	80	80	80	80	77	74	71	68
	1800	80	80	80	80	80	80	79	75	72	69	67
	1750	80	80	80	80	80	80	77	73	70	67	65
	1700	80	80	80	80	80	78	74	71	68	65	63
	1650	80	80	80	80	79	76	72	69	66	63	61
	1600	80	80	80	80	77	73	70	67	64	62	59
	1550	80	80	80	78	75	71	68	65	62	60	57
	1500	80	80	80	76	72	69	66	63	60	58	56
1450	80	80	78	73	70	66	63	61	58	56	54	
1540	80											
	926	700	800	900	950	1000	1050	1100	1150	1200	1250	1300
	Door leaf width (mm)**											

Test specifications:

- 2 hinges: Hinge spacing 1540 mm - Door leaf width 926 mm - Opening angle 0°-90°.

**With door dimensions and max opening angle different from the tested configuration and/or with the application of other devices such as, for example, door closers/bumpers/emergency handle/dropdown seal/etc. refer to the "Installation Examples". Please note that testing for these configurations is under customer's responsibility. We specify that the combinations are the result of interpolation and not of real tests, which remain under the customer's responsibility.

Standard application

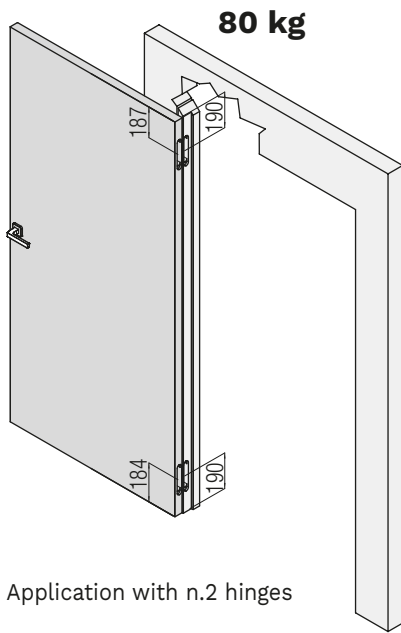

Application with n.2 hinges

Milling door/jamb

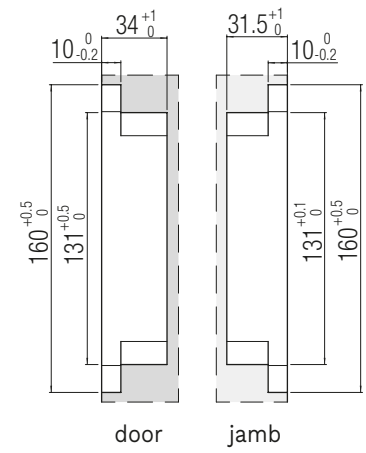

Installation of Hinge centered on the door leaf

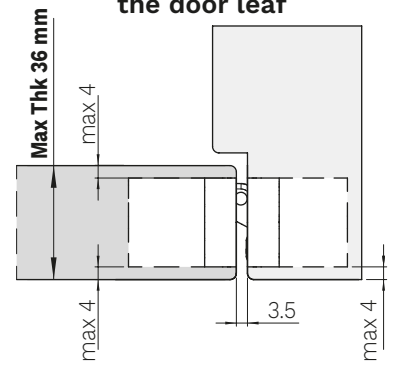

Installation of Hinge NOT centered on the door leaf

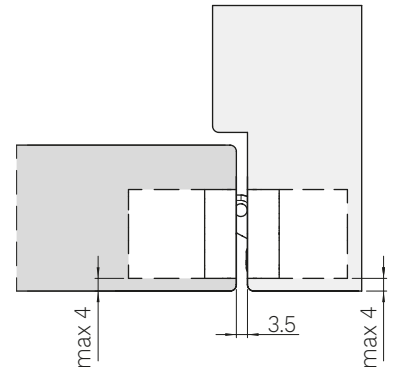

Fixing screws included

The hinge fixing is ensured by using the **fixing screws** indicated in the hinge assembly instructions.

MADE IN ITALY

HINGE MATERIAL Zamak	LOAD CAPACITY 80 kg (n.2 hinges) 100 kg (n.3 hinges) 	APPLICATION Flush to the wall door 	K DISTANCE K-max 4 mm
HINGE CENTERED ON THE DOOR LEAF Max Thk 38 mm	OPENING ANGLE 180° 	3D ADJUSTMENTS Z +3 / -3 X +3 / -2 Y +1 / -1	TESTED WITH DOOR CLOSER*
FINISHING Full HD 	INTERCHANGEABLE WITH: K7316 	COVER MATERIAL Aluminum 	NUMBER OF ROTATION AXES 7
MAGNETIC COVER 	SUITABLE FOR kiker	COVER MATERIAL Aluminum 	MAGNETIC COVER
CE	SUITABLE FOR Suitable for high opening and closing environment	EN 1634-1 30 min.	EN 1670 Spray salt tested 240 hours

Product Quality
ift
Multi-axis, concealed hinges
EAD 020001-01-0405
Reg.-N°: 9000283

Rif. report reference
N° R27182-20130522
UL US LISTED

EN 1634-1

30 min.

CE	Krona Koblenz SpA Via Romero, 1 47853 Coriano	24
0757	ETA-11/0477 D4P/D4P-M: 001ITA/CPR/2024-06-07	3 7 4 1 1 4 0 11
0757-CPR-228EAD-9000283-1-4 HINGES DO NOT CONTAIN HARMFUL SUBSTANCES		KUBI7 K7080

<https://www.kronakoblenz.com/certificazioni/pdf/ce-certificate-k7120-k7080-koblenz.pdf>

EN 1670
Spray salt tested
240 hours

*Tested with door closer models most frequently used on the market.



Classic Series

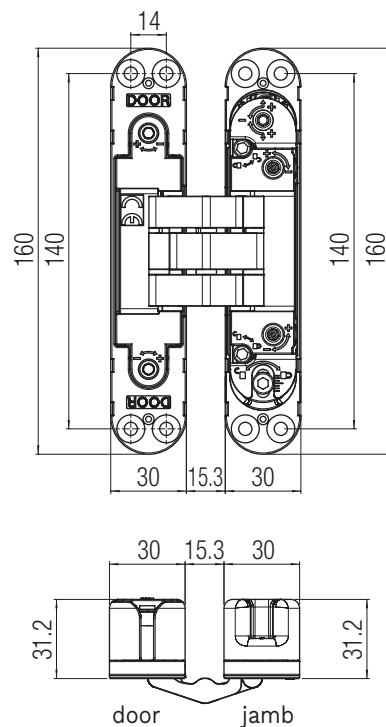

Finishing

Colour	Item number. standard	Item number. magnetic
Antique bronze	K 7080 BA	
Polished chrome	K 7080 CL HD	
Satin chrome	K 7080 CS HD	K 7080 CS CM
Umbr grey	K 7080 GO HD	
Satin nickel	K 7080 NS HD	
Polished gold	K 7080 OL HD	
Bronze	K 7080 BR HD	
White	K 7080 BI HD	
Black	K 7080 NO HD	K 7080 NO CM

For other colours please ask Krona Koblenz for feasibility

Load capacity table (see the reading guide at page 12)

K7080 - 80 Kg - N.2 hinges												
2000	80	80	80	80	80	80	80	80	80	77	74	
1950	80	80	80	80	80	80	80	80	80	78	75	
1900	80	80	80	80	80	80	80	80	79	76	73	
1850	80	80	80	80	80	80	80	80	77	74	71	
1800	80	80	80	80	80	80	80	79	75	72	69	
1750	80	80	80	80	80	80	80	77	73	70	67	
1700	80	80	80	80	80	78	74	71	68	65	63	
1650	80	80	80	80	79	76	72	69	66	63	61	
1600	80	80	80	80	77	73	70	67	64	62	59	
1550	80	80	80	78	75	71	68	65	62	60	57	
1500	80	80	80	76	72	69	66	63	60	58	56	
1450	80	80	78	73	70	66	63	61	58	56	54	
1540	80											
	926	700	800	900	950	1000	1050	1100	1150	1200	1250	1300
Door leaf width (mm)**												

K7080 - 100 Kg - N.3 hinges												
2000	100	100	100	100	100	99	95	90	87	83	80	
1950	100	100	100	100	100	97	92	88	85	81	78	
1900	100	100	100	100	99	94	90	86	82	79	76	
1850	100	100	100	100	96	92	87	84	80	77	74	
1800	100	100	100	99	94	89	85	81	78	75	72	
1750	100	100	100	96	91	87	83	79	76	73	70	
1700	100	100	98	93	88	84	80	77	74	71	68	
1650	100	100	95	90	86	82	78	75	72	69	66	
1600	100	100	92	88	83	79	76	72	69	67	64	
1550	100	100	90	85	81	77	73	70	67	65	62	
1500	100	98	87	82	78	74	71	68	65	62	60	
1450	100	94	84	79	75	72	69	66	63	60	58	
1730	100											
	900	700	800	900	950	1000	1050	1100	1150	1200	1250	1300
Door leaf width (mm)**												

Test specifications:

- 2 hinges: Hinge spacing 1540 mm - Door leaf width 926 mm - Opening angle 0°-90°.
- 3 hinges: Hinge spacing 1730 mm - Door leaf width 900 mm - Opening angle 0°-90°.

**With door dimensions and max opening angle different from the tested configuration and/or with the application of other devices such as, for example, door closers/bumpers/emergency handle/dropdown seal/etc. refer to the "Installation Examples". Please note that testing for these configurations is under customer's responsibility. We specify that the combinations are the result of interpolation and not of real tests, which remain under the customer's responsibility.

Standard application

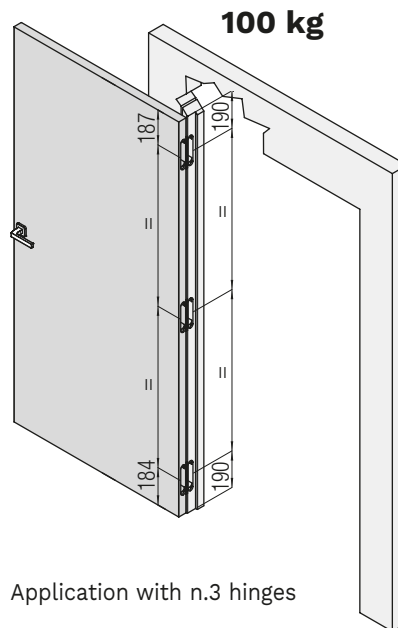
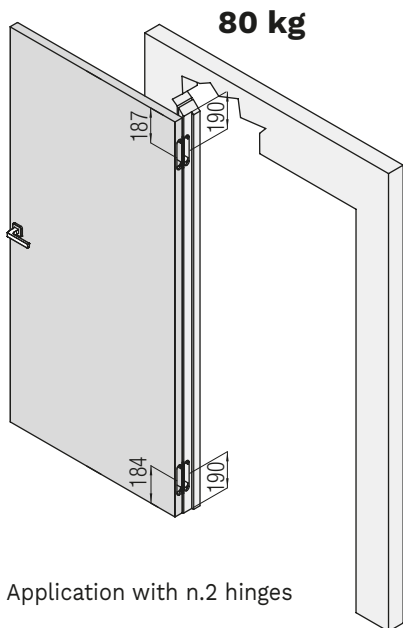

Milling door/jamb

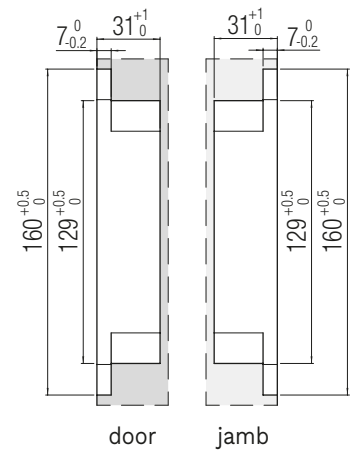

Installation of Hinge centered on the door leaf

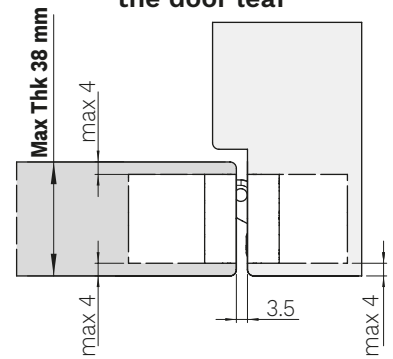

Installation of Hinge NOT centered on the door leaf

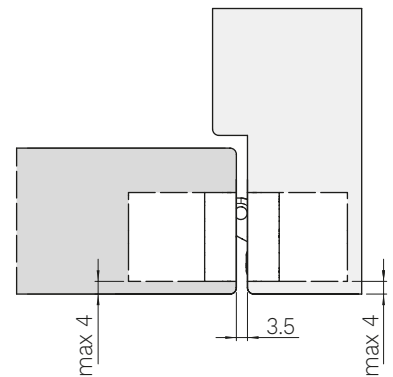





⚠ Fixing screws included

The hinge fixing is ensured by using the **fixing screws** indicated in the hinge assembly instructions.

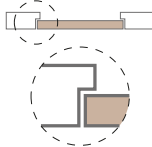
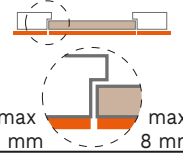
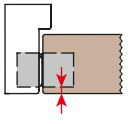
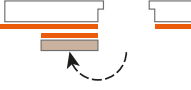
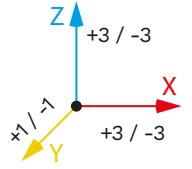
Kross8¹⁰⁰ K2810

MADE IN ITALY

HINGE MATERIAL Zamak	LOAD CAPACITY 100 kg (n.2 hinges) 	APPLICATION Flush to the wall door 	APPLICATION Cladding 
K DISTANCE  K-max 8 mm	OPENING ANGLE 180° 	3D ADJUSTMENTS 	FINISHING Full HD 
COVER MATERIAL Steel  Cover with screws	BURGLAR-PROOF DOOR 	NUMBER OF ROTATION AXES 5 	Suitable for high opening and closing environment

EN 1634-1
BS476-22



30 min.

Classic Series

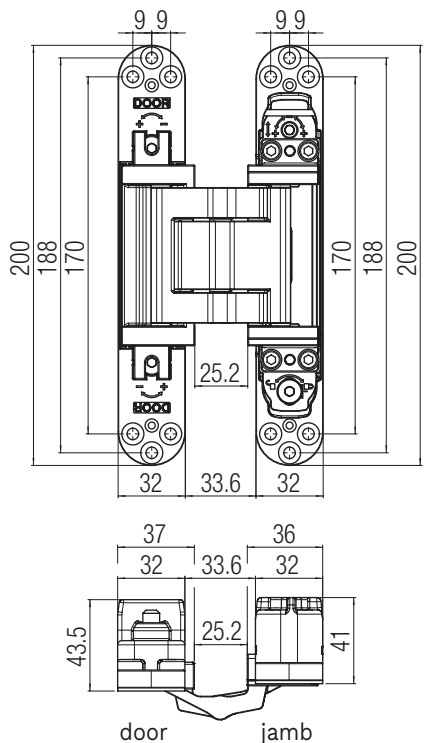
200 188 170 9 9 9 9 170 188 200 32 33.6 32 25.2 37 32 33.6 32 43.5 25.2 41 door jamb

Finishing

Colour	Item number.
Polished chrome	K 2810 CL
Satin chrome	K 2810 CS
Umbra grey	K 2810 GO
Satin nickel	K 2810 NS
Polished gold	K 2810 OL
Satin gold	K 2810 OS
Bronze	K 2810 BR
White	K 2810 BI
Black	K 2810 NO

For other colours please ask Krona Koblenz for feasibility



Product details:



Load capacity table (see the reading guide at page 12)

K2810 - 100 Kg - N.2 hinges												
Hinge spacing (mm)**	2000	100	100	100	100	100	100	100	100	100	96	93
	1950	100	100	100	100	100	100	100	100	98	94	90
	1900	100	100	100	100	100	100	100	99	95	91	88
	1850	100	100	100	100	100	100	100	97	93	89	86
	1800	100	100	100	100	100	100	98	94	90	87	83
	1750	100	100	100	100	100	100	96	92	88	84	81
	1700	100	100	100	100	100	97	93	89	85	82	79
	1650	100	100	100	100	99	94	90	86	83	79	76
	1600	100	100	100	100	96	92	87	84	80	77	74
	1550	100	100	100	98	93	89	85	81	78	75	72
	1500	100	100	100	95	90	86	82	78	75	72	69
1450	100	100	97	92	87	83	79	76	73	70	67	
1540	100											
	926	700	800	900	950	1000	1050	1100	1150	1200	1250	1300
	Door leaf width (mm)**											

Test specifications:

- 2 hinges: Hinge spacing 1540 mm - Door leaf width 926 mm - Opening angle 0°-90°.

**With door dimensions and max opening angle different from the tested configuration and/or with the application of other devices such as, for example, door closers/bumpers/emergency handle/dropdown seal/etc. refer to the "Installation Examples". Please note that testing for these configurations is under customer's responsibility. We specify that the combinations are the result of interpolation and not of real tests, which remain under the customer's responsibility.

Standard application

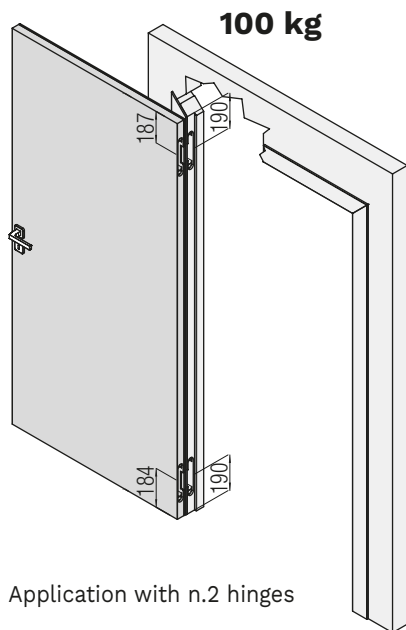

Application with n.2 hinges

Milling door/jamb

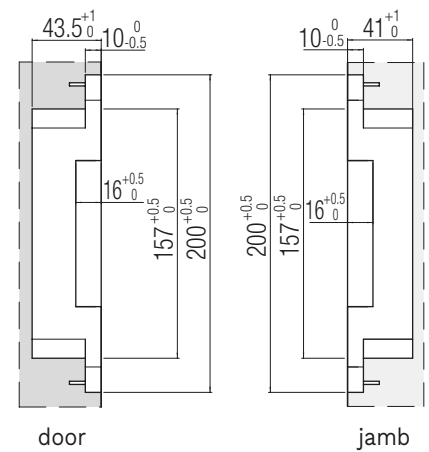

door

jamb

Installation of Hinge NOT centered on the door leaf

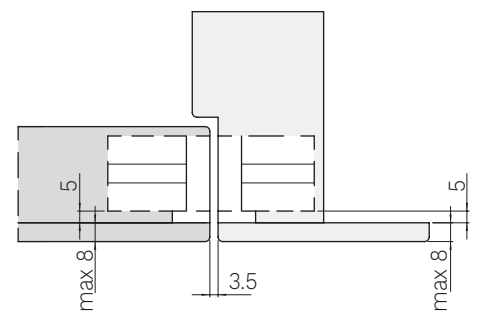

The hinge fixing is ensured by using the fixing screws indicated in our hinge assembly instructions.

MADE IN ITALY

HINGE MATERIAL Zamak	LOAD CAPACITY 120 kg (n.2 hinges) 140 kg (n.3 hinges) 	APPLICATION Flush to the wall door 	K DISTANCE K-max 4 mm
HINGE CENTERED ON THE DOOR LEAF Max Thk 40 mm	OPENING ANGLE 180° 	3D ADJUSTMENTS Z: +3 / -3 X: +3 / -2 Y: +1 / -1	NUMBER OF ROTATION AXES 7
FINISHING Full HD 	COVER MATERIAL Aluminum 	BURGLAR-PROOF DOOR 	SUITABLE FOR kiker
MAGNETIC COVER 	SUITABLE FOR Suitable for high opening and closing environment	Rif. report reference N° R27182-20130522 UL US LISTED	

ift Product Quality
Multi-axis, concealed hinges
EAD 020001-01-0405
Reg.-N°: 9000283

EN 1634-1

30 min.

EN 1670
Spray salt tested
240 hours

CE	Krona Koblenz SpA Via Romero, 1 47853 Coriano	24
0757	ETA-11/0477 DOP/DOP-M. 002/TA/CPR/2024-06-01	4 7 6 1 1 4 1 13
0757-CPR-228EAD-9000283-1-4 HINGES DO NOT CONTAIN HARMFUL SUBSTANCES		KUBI7 K7120

<https://www.kronakoblenz.com/certificazioni/pdf/ce-certificate-k7120-k7080-koblenz.pdf>

Classic Series

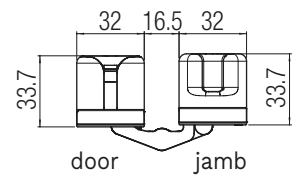
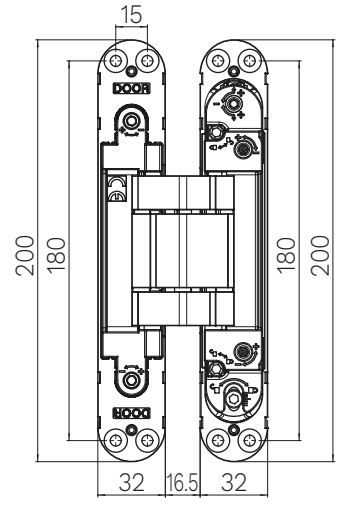

Finishing		
Colour	Item number. standard	Item number. magnetic
Antique bronze	K 7120 BA	
Satin chrome	K 7120 CS HD	K 7120 CS CM
Umbra grey	K 7120 GO HD	
Satin nickel	K 7120 NS HD	
Black	K 7120 NO HD	K 7120 NO CM

For other colours please ask Krona Koblenz for feasibility

Load capacity table (see the reading guide at page 12)

K7120 - 120 Kg - N.2 hinges												
Hinge spacing (mm)**	2000	120	120	120	120	120	120	120	120	120	115	111
	1950	120	120	120	120	120	120	120	120	117	113	108
	1900	120	120	120	120	120	120	120	119	114	110	105
	1850	120	120	120	120	120	120	120	116	111	107	103
	1800	120	120	120	120	120	120	118	113	108	104	100
	1750	120	120	120	120	120	120	115	110	105	101	97
	1700	120	120	120	120	120	117	112	107	102	98	94
	1650	120	120	120	120	119	113	108	104	99	95	92
	1600	120	120	120	120	115	110	105	100	96	92	89
	1550	120	120	120	118	112	107	102	97	93	89	86
	1500	120	120	120	114	108	103	98	94	90	87	83
	1450	120	120	116	110	105	100	95	91	87	84	80
	1540	120										
	926	700	800	900	950	1000	1050	1100	1150	1200	1250	1300
		Door leaf width (mm)**										

K7120 - 140 Kg - N.3 hinges												
Hinge spacing (mm)**	2000	140	140	140	140	140	139	132	127	121	117	112
	1950	140	140	140	140	140	135	129	123	118	114	109
	1900	140	140	140	140	138	132	126	120	115	111	106
	1850	140	140	140	140	135	128	122	117	112	108	104
	1800	140	140	140	138	131	125	119	114	109	105	101
	1750	140	140	140	134	127	121	116	111	106	102	98
	1700	140	140	138	130	124	118	113	108	103	99	95
	1650	140	140	134	126	120	114	109	104	100	96	92
	1600	140	140	129	123	117	111	106	101	97	93	90
	1550	140	140	125	119	113	108	103	98	94	90	87
	1500	140	137	121	115	109	104	99	95	91	87	84
	1450	140	132	117	111	106	101	96	92	88	84	81
	1730	140										
	900	700	800	900	950	1000	1050	1100	1150	1200	1250	1300
		Door leaf width (mm)**										

Test specifications:

- 2 hinges: Hinge spacing 1540 mm - Door leaf width 926 mm - Opening angle 0°-90°.
- 3 hinges: Hinge spacing 1730 mm - Door leaf width 900 mm - Opening angle 0°-90°.

**With door dimensions and max opening angle different from the tested configuration and/or with the application of other devices such as, for example, door closers/bumpers/emergency handle/dropdown seal/etc. refer to the "Installation Examples". Please note that testing for these configurations is under customer's responsibility. We specify that the combinations are the result of interpolation and not of real tests, which remain under the customer's responsibility.

Standard application

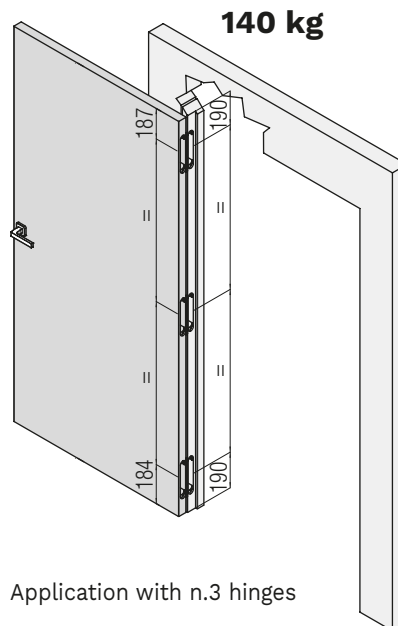
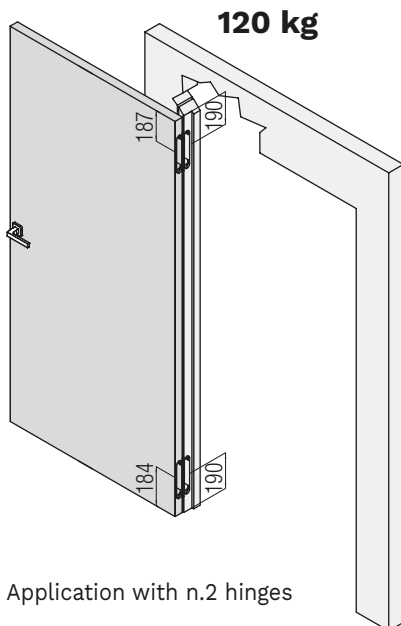

Milling door/jamb

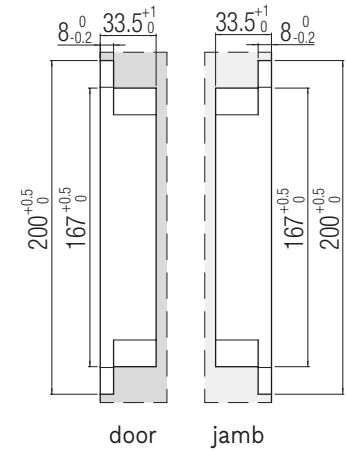

Installation of Hinge centered on the door leaf

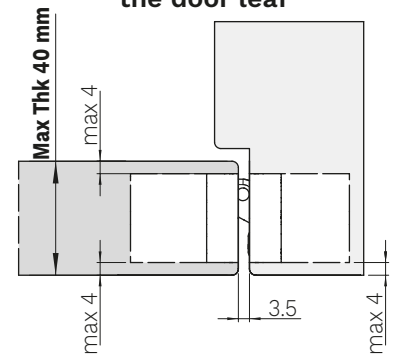



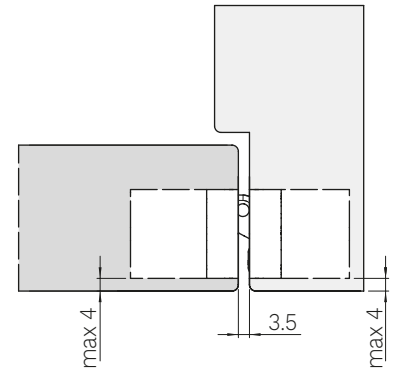

Installation of Hinge NOT centered on the door leaf

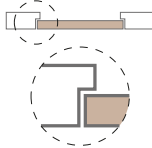
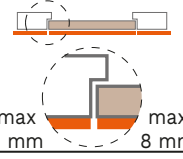
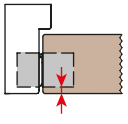
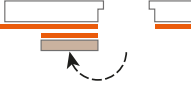
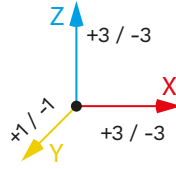

Fixing screws included
The hinge fixing is ensured by using the **fixing screws** indicated in the hinge assembly instructions.

Kross8¹⁶⁰ K2816

MADE IN ITALY

HINGE MATERIAL Zamak	LOAD CAPACITY 160 kg (n.2 hinges) 	APPLICATION Flush to the wall door 	APPLICATION Cladding 
K DISTANCE  K-max 8 mm	OPENING ANGLE 180° 	3D ADJUSTMENTS 	FINISHING Full HD 
COVER MATERIAL Steel  Cover with screws	BURGLAR-PROOF DOOR 	NUMBER OF ROTATION AXES 5 	Suitable for high opening and closing environment

Classic Series

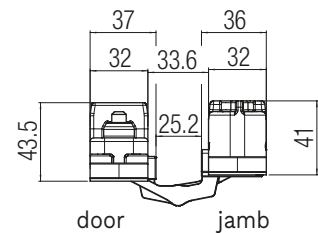
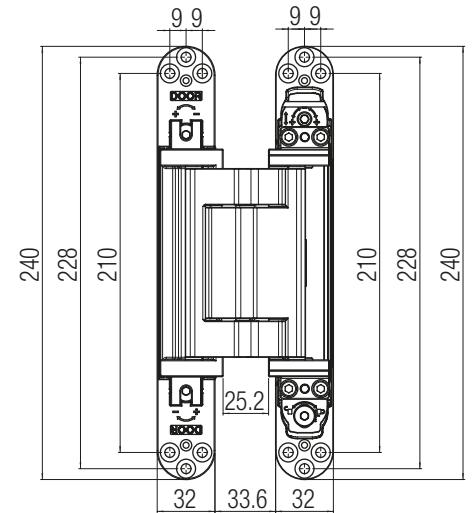

Finishing

Colour	Item number.
Antique bronze	K 2816 BA
Polished chrome	K 2816 CL
Satin chrome	K 2816 CS
Satin nickel	K 2816 NS
Polished gold	K 2816 OL
Bronze	K 2816 BR
White	K 2816 BI
Black	K 2816 NO

For other colours please ask Krona Koblenz for feasibility

www.kronakoblenz.com



Product details:



Load capacity table (see the reading guide at page 12)

K2816 - 160 Kg - N.2 hinges												
Hinge spacing (mm)**	2000	160	160	160	160	160	160	160	160	160	154	148
	1950	160	160	160	160	160	160	160	160	156	150	144
	1900	160	160	160	160	160	160	160	159	152	146	141
	1850	160	160	160	160	160	160	160	160	155	148	142
	1800	160	160	160	160	160	160	157	151	144	139	133
	1750	160	160	160	160	160	160	153	146	140	135	130
	1700	160	160	160	160	160	156	149	142	136	131	126
	1650	160	160	160	160	159	151	144	138	132	127	122
	1600	160	160	160	160	154	147	140	134	128	123	118
	1550	160	160	160	157	149	142	136	130	124	119	115
	1500	160	160	160	152	144	137	131	125	120	115	111
	1450	160	160	155	147	140	133	127	121	116	112	107
1540	160											
	926	700	800	900	950	1000	1050	1100	1150	1200	1250	1300
		Door leaf width (mm)**										

Test specifications:

- 2 hinges: Hinge spacing 1540 mm - Door leaf width 926 mm - Opening angle 0°-90°.

**With door dimensions and max opening angle different from the tested configuration and/or with the application of other devices such as, for example, door closers/bumpers/emergency handle/dropdown seal/etc. refer to the "Installation Examples". Please note that testing for these configurations is under customer's responsibility. We specify that the combinations are the result of interpolation and not of real tests, which remain under the customer's responsibility.

Standard application

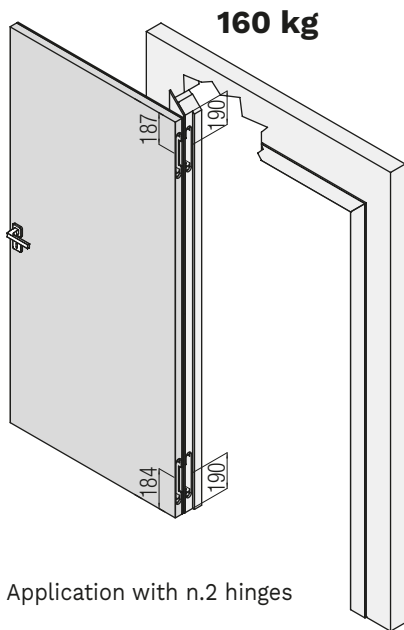

Application with n.2 hinges

Milling door/jamb

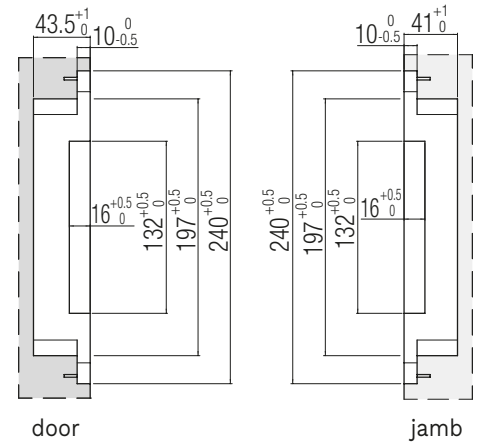



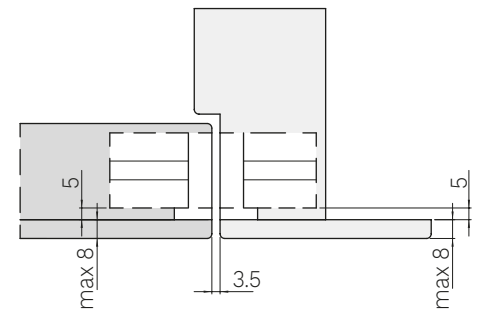



Installation of Hinge NOT centered on the door leaf

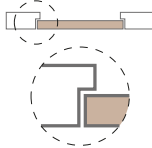
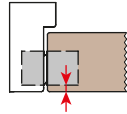
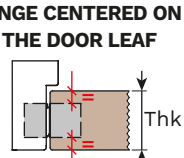
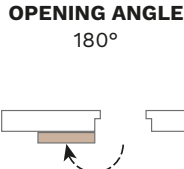
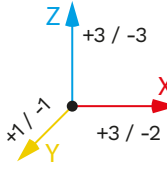
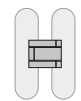

The hinge fixing is ensured by using the fixing screws indicated in our hinge assembly instructions.

MADE IN ITALY

HINGE MATERIAL Zamak	LOAD CAPACITY 200 kg (n.2 hinges) 	APPLICATION Flush to the wall door 	K DISTANCE  K-max 4 mm
HINGE CENTERED ON THE DOOR LEAF  Max Thk 40 mm	OPENING ANGLE 180° 	3D ADJUSTMENTS  Z: +3 / -3 X: +3 / -2 Y: +1 / -1	NUMBER OF ROTATION AXES 7 
FINISHING Full HD 	COVER MATERIAL Aluminum 	BURGLAR-PROOF DOOR 	EN 1670 Spray salt tested 240 hours
SUITABLE FOR 	Suitable for high opening and closing environment	Rif. report reference N° R27182-20130522 	

Classic Series

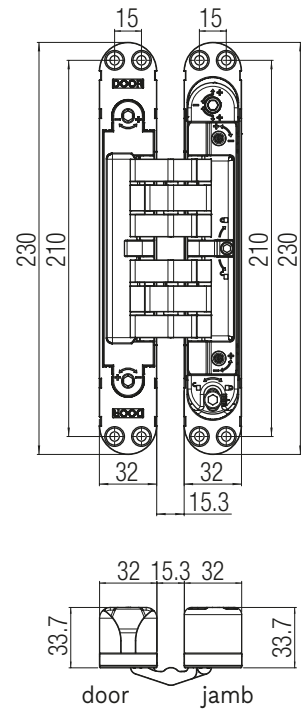

Finishing

Colour	Item number.
Antique bronze	K 7200 BA
Satin chrome	K 7200 CS HD
Satin nickel	K 7200 NS HD
Polished gold	K 7200 OR HD
Bronze	K 7200 BR HD
Black	K 7200 NO HD

For other colours please ask Krona Koblenz for feasibility



Product details:



Load capacity table (see the reading guide at page 12)

K7200 - 200 Kg - N.2 hinges												
2000	200	200	200	200	200	198	189	181	173	166	160	
1950	200	200	200	200	200	193	184	176	169	162	156	
1900	200	200	200	200	198	188	180	172	165	158	152	
1850	200	200	200	200	192	183	175	167	160	154	148	
1800	200	200	200	197	187	178	170	163	156	150	144	
1750	200	200	200	192	182	173	166	158	152	146	140	
1700	200	200	197	186	177	168	161	154	147	142	136	
1650	200	200	191	181	172	164	156	149	143	137	132	
1600	200	200	185	175	166	159	151	145	139	133	128	
1550	200	200	179	170	161	154	147	140	134	129	124	
1500	200	195	173	164	156	149	142	136	130	125	120	
1450	200	189	168	159	151	144	137	131	126	121	116	
1730	200											
	900	700	800	900	950	1000	1050	1100	1150	1200	1250	1300
	Door leaf width (mm)**											

Test specifications:

- 2 hinges: Hinge spacing 1730 mm - Door leaf width 900 mm - Opening angle 0°-90°.

**With door dimensions and max opening angle different from the tested configuration and/or with the application of other devices such as, for example, door closers/bumpers/emergency handle/dropdown seal/etc. refer to the "Installation Examples". Please note that testing for these configurations is under customer's responsibility. We specify that the combinations are the result of interpolation and not of real tests, which remain under the customer's responsibility.

Standard application

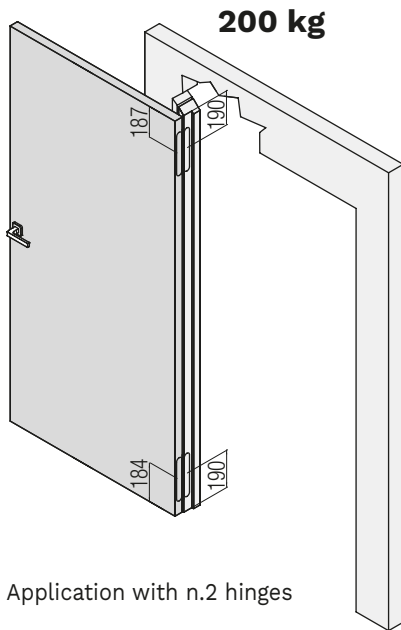

Application with n.2 hinges

Milling door/jamb

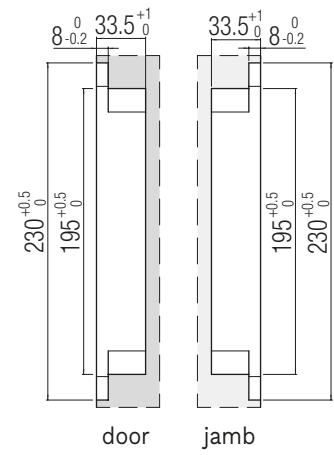

Installation of Hinge centered on the door leaf

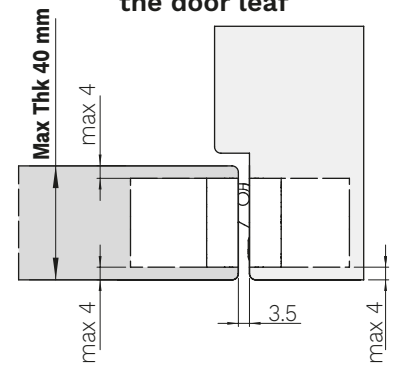

Installation of Hinge NOT centered on the door leaf

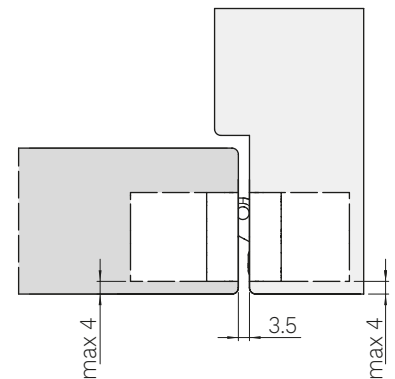

Fixing screws included

The hinge fixing is ensured by using the **fixing screws** indicated in the hinge assembly instructions.

Finishes and Accessories



Warnings

Accessories

Finishes

Classic Series

Evolution Series

Performance Series

Legenda

Vademecum

Index

COVER CAPS FINISHES AND SPARE PARTS

FINISH SAMPLES



Polished chrome
K 8060 CL HD



Satin chrome
K 8060 CS HD



Satin steel
K 7316 AS



Polished nickel
K 6200 NL HD



Satin nickel
K 8060 NS HD

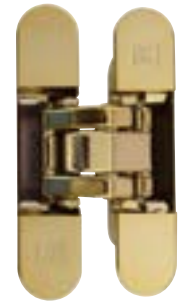

Polished gold
K 8060 OL HD



Satin gold
K 6400 OS

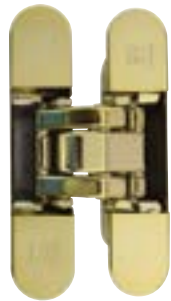

Polished brass
K 8060 OTL HD



Bronze
K 8060 BR HD

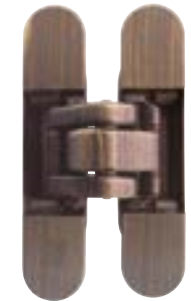

Brushed bronze
K 8060 BS HD



Imperial bronze
K 6400 IBU



Anthracite grey
K 6200 AN HD



Antique bronze
K 7080 BA



Umbra grey
K 7080 GO HD



Black
K 8060 NO HD



White
K 8060 BI HD





COVER CAPS SPARE PARTS

Atomika K8000		
Colour	Item number. standard	Item number. magnetic
Polished chrome	K 800 COVER CL	K 800 COVER CL CM
Satin chrome	K 800 COVER CS	K 800 COVER CS CM
Satin nickel	K 800 COVER NS	K 800 COVER NS CM
Polished gold	K 800 COVER OL	K 800 COVER OL CM
Bronze	K 800 COVER BR	K 800 COVER BR CM
Brushed bronze	K 800 COVER BS	
Polished brass	K 800 COVER OTL	K 800 COVER OTL CM
White	K 800 COVER BI	K 800 COVER BI CM
Black	K 800 COVER NO	K 800 COVER NO CM

Atomika Karakter K8120		
Colour	Item number. standard	Item number. magnetic
Satin chrome	K 808 COVER CS	K 808 COVER CS CM
Black	K 808 COVER NO	K 808 COVER NO CM
Cover with screws		
Satin chrome	K 808 COVER CS CV	
Black	K 808 COVER NO CV	

Kombi Hybrid K1019		
Colour	Item number. standard	Item number. magnetic
Polished chrome	K 1019 COVER CL	K 1019 COVER CL CM
Satin chrome	K 1019 COVER CS	K 1019 COVER CS CM
Satin nickel	K 1019 COVER NS	K 1019 COVER NS CM
Polished gold	K 1019 COVER OL	K 1019 COVER OL CM
Satin gold	K 1019 COVER OS	K 1019 COVER OS CM
Bronze	K 1019 COVER BR	K 1019 COVER BR CM
White	K 1019 COVER BI	K 1019 COVER BI CM
Black	K 1019 COVER NO	K 1019 COVER NO CM

Atomika Slim K8060		
Colour	Item number. standard	Item number. magnetic
Polished chrome	K 806 COVER CL	K 806 COVER CL CM
Satin chrome	K 806 COVER CS	K 806 COVER CS CM
Satin nickel	K 806 COVER NS	K 806 COVER NS CM
Polished gold	K 806 COVER OL	K 806 COVER OL CM
Satin gold	K 806 COVER OS	
Bronze	K 806 COVER BR	K 806 COVER BR CM
Brushed bronze	K 806 COVER BS	K 806 COVER BS CM
Polished brass	K 806 COVER OTL	K 806 COVER OTL CM
Satin brass	K 806 COVER OTS	
White	K 806 COVER BI	K 806 COVER BI CM
Black	K 806 COVER NO	K 806 COVER NO CM

KuBi7 Kinox K7316	
Colour	Item number. standard
Cover with screws	
Satin steel	K 731 COVER AS CV

Kombi Hybrid K1019 26		
Colour	Item number. standard	Item number. magnetic
Satin chrome	K 1019 26 COVER CS	
Satin nickel	K 1019 26 COVER NS	
White	K 1019 26 COVER BI	
Black	K 1019 26 COVER NO	

Atomika Karakter K8080		
Colour	Item number. standard	Item number. magnetic
Polished chrome	K 808 COVER CL	K 808 COVER CL CM
Satin chrome	K 808 COVER CS	K 808 COVER CS CM
Satin nickel	K 808 COVER NS	K 808 COVER NS CM
Polished gold	K 808 COVER OL	K 808 COVER OL CM
Bronze	K 808 COVER BR	K 808 COVER BR CM
Brushed bronze	K 808 COVER BS	K 808 COVER BS CM
Polished brass	K 808 COVER OTL	K 808 COVER OTL CM
White	K 808 COVER BI	K 808 COVER BI CM
Black	K 808 COVER NO	K 808 COVER NO CM
Cover with screws		
Satin chrome	K 808 COVER CS CV	
Satin nickel	K 808 COVER NS CV	
Black	K 808 COVER NO CV	

Kombi Hybrid K1019 30		
Colour	Item number. standard	Item number. magnetic
Satin chrome	K 1019 30 COVER CS	
Satin nickel	K 1019 30 COVER NS	
White	K 1019 30 COVER BI	
Black	K 1019 30 COVER NO	

Kombi Hybrid K1019 34		
Colour	Item number. standard	Item number. magnetic
Satin chrome	K 1019 34 COVER CS	
Satin nickel	K 1019 34 COVER NS	
Polished gold	K 1019 34 COVER OL	
White	K 1019 34 COVER BI	
Black	K 1019 34 COVER NO	

Kombi Hybrid K1060 30		
Colour	Item number. standard	Item number. magnetic
Satin chrome	K 1019 30 COVER CS	
Satin nickel	K 1019 30 COVER NS	
White	K 1019 30 COVER BI	
Black	K 1019 30 COVER NO	

Kubica K6360 38		
Colour	Item number. standard	Item number. magnetic
Polished chrome	K 63 38 COVER CL	K 63 38 COVER CL CM
Satin chrome	K 63 38 COVER CS	K 63 38 COVER CS CM
Satin nickel	K 63 38 COVER NS	K 63 38 COVER NS CM
Polished gold	K 63 38 COVER OL	K 63 38 COVER OL CM
Satin gold	K 63 38 COVER OS	K 63 38 COVER OS CM
Bronze	K 63 38 COVER BR	K 63 38 COVER BR CM
Polished brass	K 63 38 COVER OTL	K 63 38 COVER OTL CM
White	K 63 38 COVER BI	K 63 38 COVER BI CM
Black	K 63 38 COVER NR	K 63 38 COVER NR CM

Kombi Hybrid K1060		
Colour	Item number. standard	Item number. magnetic
Satin chrome	K 1019 COVER CS	
Satin nickel	K 1019 COVER NS	
White	K 1019 COVER BI	
Black	K 1019 COVER NO	

Kombi Hybrid K1060 34		
Colour	Item number. standard	Item number. magnetic
Satin chrome	K 1019 34 COVER CS	
Satin nickel	K 1019 34 COVER NS	
White	K 1019 34 COVER BI	
Black	K 1019 34 COVER NO	

Kubica K6360 45		
Colour	Item number. standard	Item number. magnetic
Polished chrome		K 63 45 COVER CL CM
Satin chrome	K 63 45 COVER CS	K 63 45 COVER CS CM
Satin nickel	K 63 45 COVER NS	K 63 45 COVER NS CM
Polished gold		K 63 45 COVER OL CM
Satin gold	K 63 45 COVER OS	K 63 45 COVER OS CM
Bronze	K 63 45 COVER BR	K 63 45 COVER BR CM
Polished brass		K 63 45 COVER OTL CM
White	K 63 45 COVER BI	K 63 45 COVER BI CM
Black	K 63 45 COVER NR	K 63 45 COVER NR CM

Kombi Hybrid K1060 26		
Colour	Item number. standard	Item number. magnetic
Satin chrome	K 1019 26 COVER CS	
Satin nickel	K 1019 26 COVER NS	
White	K 1019 26 COVER BI	
Black	K 1019 26 COVER NO	

Kubica K2460		
Colour	Item number. standard	Item number. magnetic
Satin chrome	K 246 COVER CS	K 246 COVER CS CM
Satin nickel	K 246 COVER NS	K 246 COVER NS CM
Polished gold	K 246 COVER OL	
Satin gold	K 246 COVER OS	
Bronze	K 246 COVER BR	K 246 COVER BR CM
White	K 246 COVER BI	K 246 COVER BI CM
Black	K 246 COVER NO	K 246 COVER NO CM

Kubica K2760		
Colour	Item number. standard	Item number. magnetic
Polished chrome	K 2760 COVER CL	K 2760 COVER CL CM
Satin chrome	K 2760 COVER CS	K 2760 COVER CS CM
Satin nickel	K 2760 COVER NS	K 2760 COVER NS CM
Polished gold	K 2760 COVER OL	K 2760 COVER OL CM
Satin gold	K 2760 COVER OS	
Bronze	K 2760 COVER BR	K 2760 COVER BR CM
Brushed bronze	K 2760 COVER BS	
White	K 2760 COVER BI	K 2760 COVER BI CM
Black	K 2760 COVER NO	K 2760 COVER NO CM





Kubica K2780		
Colour	Item number. standard	Item number. magnetic
Polished chrome		K 2760 COVER CL CM
Satin chrome	K 2760 COVER CS	K 2760 COVER CS CM
Satin nickel	K 2760 COVER NS	K 2760 COVER NS CM
Polished gold	K 2760 COVER OL	K 2760 COVER OL CM
Satin gold	K 2760 COVER OS	
Bronze		K 2760 COVER BR CM
White	K 2760 COVER BI	K 2760 COVER BI CM
Black	K 2760 COVER NO	K 2760 COVER NO CM

Kubica K6380 38		
Colour	Item number. standard	Item number. magnetic
Polished chrome		K 63 38 COVER CL
Satin chrome	K 63 38 COVER CS	
Satin nickel	K 63 38 COVER NS	
Polished gold	K 63 38 COVER OL	
Satin gold	K 63 38 COVER OS	
Bronze	K 63 38 COVER BR	
Polished brass	K 63 38 COVER OTL	
White	K 63 38 COVER BI	
Black	K 63 38 COVER NR	

Kubica K6380 45		
Colour	Item number. standard	Item number. magnetic
Satin chrome	K 63 45 COVER CS	
Satin nickel	K 63 45 COVER NS	
Satin gold	K 63 45 COVER OS	
Bronze	K 63 45 COVER BR	
White	K 63 45 COVER BI	
Black	K 63 45 COVER NR	

Kubikina New K6100	
Colour	Item number. standard
Satin chrome	K 61 COVER CS HD
White	K 61 COVER BI HD
Black	K 61 COVER NO HD

Kubica KubiCenter K6400	
Colour	Item number. standard
Satin chrome	K 64 COVER CS
Satin nickel	K 64 COVER NS
Satin gold	K 64 COVER OS

KuBi7 K7000	
Colour	Item number. standard
Satin chrome	K 70 COVER CS
Satin nickel	K 70 COVER NS
Polished gold	K 70 COVER OR
Black	K 70 COVER NR

Kubica K6200	
Colour	Item number. standard
Polished chrome	K 62 COVER CL
Satin chrome	K 62 COVER CS
Satin nickel	K 62 COVER NS
Polished gold	K 62 COVER OR
Bronze	K 62 COVER BR
Black	K 62 COVER NR

Kubica KubiKuadra K3000	
Colour	Item number. standard
Satin chrome	K 30 COVER CS
Satin nickel	K 30 COVER NS
Polished gold	K 30 COVER OR

Kubica K6700	
Colour	Item number. standard
Polished chrome	K 67 COVER CL
Satin chrome	K 67 COVER CS
Satin nickel	K 67 COVER NS
Polished gold	K 67 COVER OR
Black	K 67 COVER NO
Cover with screws	
Satin nickel	K 67 COVER NS CV
Polished gold	K 67 COVER OR CV

Kubica K6300	
Colour	Item number. standard
Satin chrome	K 6300 COVER CS
Satin nickel	K 6300 COVER NS

Kubica 27 K2700	
Colour	Item number. standard
Polished chrome	K 27 COVER CL
Satin chrome	K 27 COVER CS
Satin nickel	K 27 COVER NS
Polished gold	K 27 COVER OR

KuBi7 Kubica Twist K2000	
Colour	Item number. standard
Satin chrome	K 708 COVER CS
Satin nickel	K 708 COVER NS



Kubica K5080	
Colour	Item number. standard
Cover with screws	
Antique bronze	K 508 COVER BA CV
Satin chrome	K 508 COVER CS CV
Satin nickel	K 508 COVER NS CV
Polished gold	K 508 COVER OR CV
Bronze	K 508 COVER BR CV
Black	K 508 COVER NR CV

KuBi7 K7080	
Colour	Item number. standard
Antique bronze	K 708 COVER BA
Satin chrome	K 708 COVER CS
Satin nickel	K 708 COVER NS
Polished gold	K 708 COVER OR
Bronze	K 708 COVER BR
White	K 708 COVER BI
Imperial bronze	K 708 COVER IBU

Kross8 100 K2810	
Colour	Item number. standard
Cover with screws	
Satin chrome	K 28 COVER CS CV
Satin nickel	K 28 COVER NS CV
Bronze	K 28 COVER BR CV
Black	K 28 COVER NO CV

KuBi7 K7120	
Colour	Item number. standard
Satin chrome	K 712 COVER CS
Satin nickel	K 712 COVER NS

Kross8 160 K2816	
Colour	Item number. standard
Cover with screws	
Satin chrome	K 28 COVER CS CV
Satin nickel	K 28 COVER NS CV
Bronze	K 28 COVER BR CV
Black	K 28 COVER NO CV

KuBi7 K7200	
Colour	Item number. standard
Satin chrome	K 712 COVER CS
Satin nickel	K 712 COVER NS

SPACERS MAGNETIC COVER

Model	Item number.
Atomika K 8000	K 800 D CM
Atomika Slim K 8060	K 806 D CM
Atomika Karakter K8080 / K8120	K 808 D CM
Kombi Hybrid K1019 / K1060	K 1019 D CM
Kubica K2460	K 246 D CM
Kubica K2760 / K2780	K 276 D CM
Kubica K6360 38 / K6380 38	K 6338 D CM

ACCESSORIES

UNIVERSAL JIG

An accessory made of aluminum and steel for manual milling of the door leaf. To be used together with a template corresponding to the hinge model to install.

	Item number.
Universal jig	K.DIMA

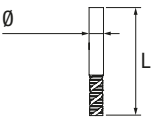
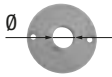

TEMPLATES

Hinge	Item number.		
Atomika K8000	K.800	16 mm	30 mm
Atomika Slim K8060	K.806	16 mm	30 mm
Atomika Karakter K8080	K.508	16 mm	30 mm
Atomika Karakter K8120	K.508	16 mm	30 mm
KuBi7 KINOX K7316	K.708	16 mm	30 mm
Kombi Hybrid K1019	K.100	16 mm	30 mm
Kombi Hybrid K1060	K.100	16 mm	30 mm
Kubica K6360 38	K.636 38	16 mm	30 mm
Kubica K6360 45	K.636 45	16 mm	30 mm
Kubica K6380 38	K.636 38	16 mm	30 mm
Kubica K6380 45	K.636 45	16 mm	30 mm
Kubica K2760	K.276	16 mm	30 mm
Kubica K2780	K.276	16 mm	30 mm
Kubica K2460	K.240	16 mm	30 mm
Kubikina New K6100	K.610	10 mm	30 mm
Kubica K5080	K.508	16 mm	30 mm
Kubica K6200	K.620	16 mm	30 mm
Kubica K6700	K.670	16 mm	30 mm
Kubica K6300	K.630	12 mm	30 mm
Kubica 27 K2700	K.270	16 mm	30 mm
Kubica KubiKuadra K3000	K.300	16 mm	30 mm
Kubica KubiCenter K6400	K.640	16 mm	30 mm
KuBi7 K7000	K.700	16 mm	30 mm
KuBi7 K7080	K.708	16 mm	30 mm
KuBi7 K7120	K.712	16 mm	30 mm
KuBi7 K7200	K.720	16 mm	30 mm
KuBi7 Kubica Twist K2000	K.708	16 mm	30 mm
KROSS8 100 K2810	K.2810	16 mm	30 mm
KROSS8 160 K2816	K.2816	24 mm	30 mm
Recommended cutters			
Ø 16 mm	L = 110 mm	CMT 177.161.11	
Ø 12 mm	L = 100 mm	CMT 177.121.11	
Ø 10 mm	L = 90 mm	CMT 177.100.11	



RECEIVERS

An accessory for fixing hinges to steel frames.

Hinge	Item number.
Atomika K8000	K 800 TASCA
Atomika Slim K8060	K 806 TASCA
Atomika Karakter K8080	K 508 TASCA
Atomika Karakter K8120	K 508 TASCA
Kubica K2460	K 240 TASCA
Kubica K5080	K 508 TASCA
Kubica K6200	K 620 TASCA
KuBi7 K7000	K 700 TASCA
KuBi7 K7080	K 708 TASCA
KuBi7 K7120	K 712 TASCA
KuBi7 K7200	K 720 TASCA
KuBi7 Kubica Twist K2000	K 708 TASCA



ADJUSTABLE PLATE

A suitable accessory to strengthen the fixing of the hinge on the door frame with the possibility of depth adaptation.

Solution 1: a plate with an integrated adjustment screw

Hinge	Item number.
Kubica K2460	K 240 STAFFA R PATENTED
Kubica K5080	K 508 STAFFA R PATENTED
Atomika Karakter K8080	K 508 STAFFA R PATENTED
Atomika Karakter K8120	K 508 STAFFA R PATENTED

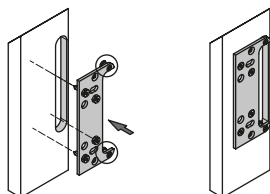

Solution 2: a plate with an integrated adjustment screw + holder (suitable for foam fixing)

Hinge	Item number.
Kubica K2460	K 240 STAFFA RV PATENTED
Kubica K5080	K 508 STAFFA RV PATENTED
Atomika Karakter K8080	K 508 STAFFA RV PATENTED
Atomika Karakter K8120	K 508 STAFFA RV PATENTED

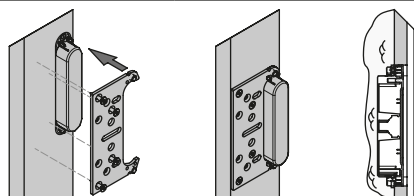

STANDARD FIXING PLATE

A suitable accessory to strengthen the fixing of the hinge on the door frame.

Solution 1: a plate with spacers

Hinge	Item number.
Atomika K8000	K 800 STAFFA
Atomika Slim K8060	K 806 STAFFA
Atomika Karakter K8080	K 508 STAFFA
Atomika Karakter K8120	K 508 STAFFA
Kubica K2460	K 240 STAFFA
Kubica K5080	K 508 STAFFA
Kubica K6200	K 620 STAFFA
KuBi7 K7000	K 700 STAFFA
KuBi7 K7080	K 708 STAFFA
KuBi7 K7120	K 712 STAFFA
KuBi7 K7200	K 720 STAFFA
KuBi7 Kubica Twist K2000	K 708 STAFFA

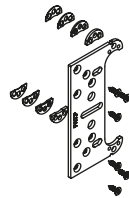

Solution 2: a plate with spacers + holder (suitable for foam fixing)

Hinge	Item number.
Kubica K2460	K 240 STAFFA SV
Kubica K5080	K 508 STAFFA SV
Atomika Karakter K8080	K 508 STAFFA SV
Atomika Karakter K8120	K 508 STAFFA SV

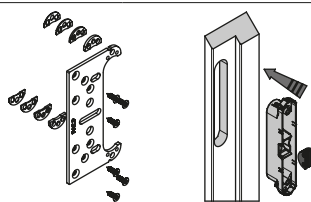

COVER TOOL

A tool to make it easier:

- to remove the film from the cover caps
- to remove the cover caps from the hinge
- to restore the flaps
- to apply the aluminum cover caps on the hinges

	Item number.
Cover Tool	K TOOL



WARNINGS AND RECOMMENDATIONS

To ensure that the hinge works correctly, it is essential to carefully evaluate all the details of the door and the frame where it will be installed.

The installer is responsible for fixing the hinge into its milling.

Krona Koblenz does not assume any responsibility for damage or injuries which may occur during the installation and/or the functioning checks, if due to failing to observe the assembly instructions, or caused by moving elements, such as glass doors, doors, showcases, etc.

Below you will find a series of recommendations and warnings to keep in mind.

How to calculate the door weight

The door weight must include the total of the weight of the door leaf, the hardware and any applied decorations.

⚠ In case of doors with glazing or glass inserts with the center of gravity different from its geometric center, we suggest checking the center of gravity or contacting Krona Koblenz for advice.



Frame and door fixing

For a correct frame and door fixing it is important that the jamb material and thickness are able to hold the hinge and keep it stable during the rotation of the door leaf.

The installer is responsible for the correct fixing and for checking the materials. The hinge must be stable during the rotation of the door leaf.

Furthermore, before installing the door leaf, it is recommended to check that the frame is perfectly aligned with the wall.

⚠ If the ratio between thickness and width is greater than $1/15$, make sure there is no collision with the jamb during the rotation (see image 1).



image 1





Installation and adjustment

The installation and adjustment of the hinges must be performed by the qualified personnel. Refer to the assembly instructions in the package or download them from the website: www.kronakoblenz.com.



Painting / Product alterations

Krona Koblenz is not liable for any inefficiencies due to the application of paints or modifications to the hinges. Do not modify or tamper with the hinges. Do not paint.

Krona Koblenz hinges are available in different colours/finishes.

Lubrication

The Krona Koblenz hinges do not require any lubrication over time thanks to the bushings made of self-lubricating and anti-wear material.

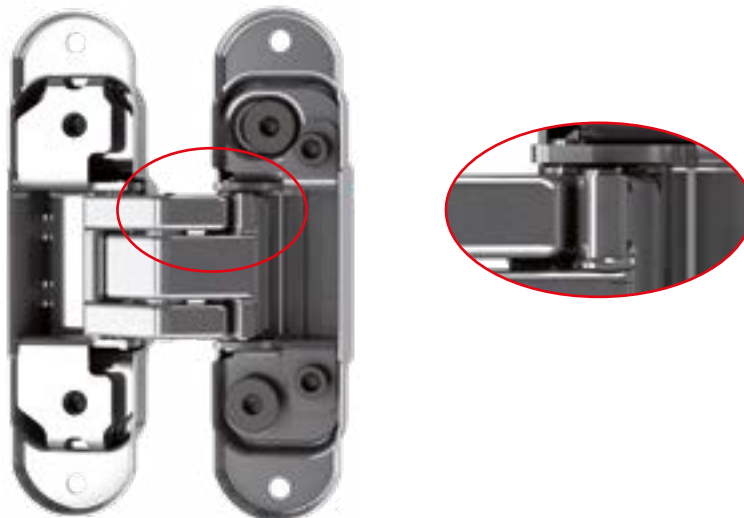

⚠ Do not lubricate the hinge.

Cleaning

The cleaning of the hinge must be done with a dry and clean cloth and only applied to the external and visible parts. Do not try to clean the internal components and mechanisms.

Avoid using solvents, surfactants, abrasives and creams.

For stainless steel hinges, use a specific product for steel.

Ordinary maintenance

During the ordinary maintenance of the doors, we suggest restoring the correct perimeter gaps as indicated in the Assembly Instructions. If this is not possible, check the frame squaring, the hinge fixing and the adjustments blocking (if applicable).

In order to make adjustments it is necessary to remove the cover caps first. We suggest you using the Cover Tools.

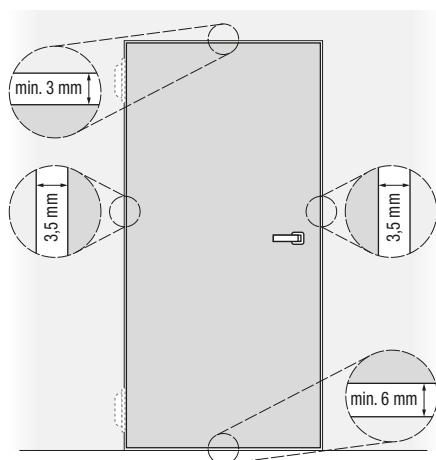

INSTALLER'S REMINDER

The hinges are the only fixing point of the door leaf and the frame and it must be carefully taken into consideration during the design and installation phases. Below you will find a list of warnings for the installer:

- Make sure the frame is square and firmly anchored to the wall before fixing the door leaf.
- For some hinge models, the fixing screws are supplied by Krona Koblenz.
- In any case, the installer must evaluate if they are suitable based on the type of material, thickness and location, as well as tighten them properly to prevent accidental unscrewing.
- Make sure that the door weight does not exceed the hinge capacity.
- Perform the adjustments following the suggested sequence "Upper-Lower-Central" without exceeding the adjustment intervals. Follow the assembly instructions or video tutorials on the Krona Koblenz YouTube channel.
- Use the adjustment wrenches in a good condition and be careful not to damage the adjustment screws.
- The screw tightening torque cannot exceed 4 Nm.
- The installation of accessories must be performed in accordance with this guide. Krona Koblenz welcomes you to have a prior evaluation.
- The ordinary product warranty is ensured only if the goods are used in a full compliance with the manufacturer's instructions.
- Do not lubricate the hinges.
- Do not paint the hinges.



Scan the QR Code below and access the latest digital and interactive version of our catalogue. Help us supporting environmental protection.



The illustrations, photos, images and technical data, features and colours of the catalogue are purely indicative and are not binding for Krona Koblenz. The deviations cannot create any reasons for not accepting the goods or compromise the contract or cause claims. All the models can be altered, improved or slightly modified in their sections, structure or drawing without any previous notification. Therefore, if at our incontestable discretion the quality and the look of our products remain unchanged, a customer will not be able either to terminate the contract or to have particular discounts or bonus.



K Krona Koblenz

OFFICES AND CONTACTS

Headquarter

ITALY

Krona Koblenz SpA

+39 0541 657040

E-mail: info@k-group.com

Via Piane, 90
47853 Coriano (RN)

SPAIN

Krona Koblenz S.L.

+34 93 591 0410

E-mail: info.espana@k-group.com

P.I. MOLI D'EN XEC NAVE n P3-3/6
_ c/ Moli d' en Xec, n 49/55
C.P. 08291 Ripollet - (Barcelona)

FRANCE

Krona Koblenz Sas

+33-474090939

E-mail: info@k-group.com

Saint Georges De Reneins (69830)
635 Boulevard Napoléon
Bullukian

RUSSIA

Крона Кобленц ООО

+7 (495) 532-74-32

E-mail: info@kronakoblenz.ru

117623, Москва,
Варшавское шоссе,
дом 268, строение 1, блок А11

INDIA

Koblenz Utturkar
Fittings Private Limited

+91 020 24540000

E-mail: info@k-group.com

FLAT No. 3, 1875, Sadashiv Peth,
Shree Balaji Prasad Society,
Pune - 411030, Maharashtra



www.kronakoblenz.com



@krona_koblenz



@Krona Koblenz



@Krona Koblenz



@Kronakoblenz